

50+ pages  
build & learn

June 2010

AUS\$ 13.90 - NZ\$ 16.90 - SAR 99.95 £ 4.65

**+ WHAT Free Audio Measuring Software**

# Elektor

www.elektor.com

**+ DMX512 Interface**

**+ LiPo Balancer**

**+ Starry Night**

**OBD2 Simulator**  
no-wheels car electronics

**Programmable  
DIY RFID**

- ✓ home-brew tags
- ✓ wireless electricity

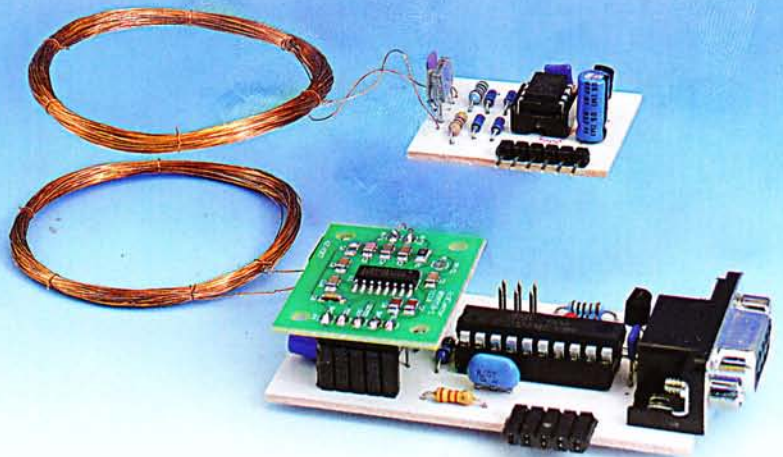

**InterSceptre Extension Board**  
opens doors (and ports) for you



# SIMPLY EASILY - EasyAVR6

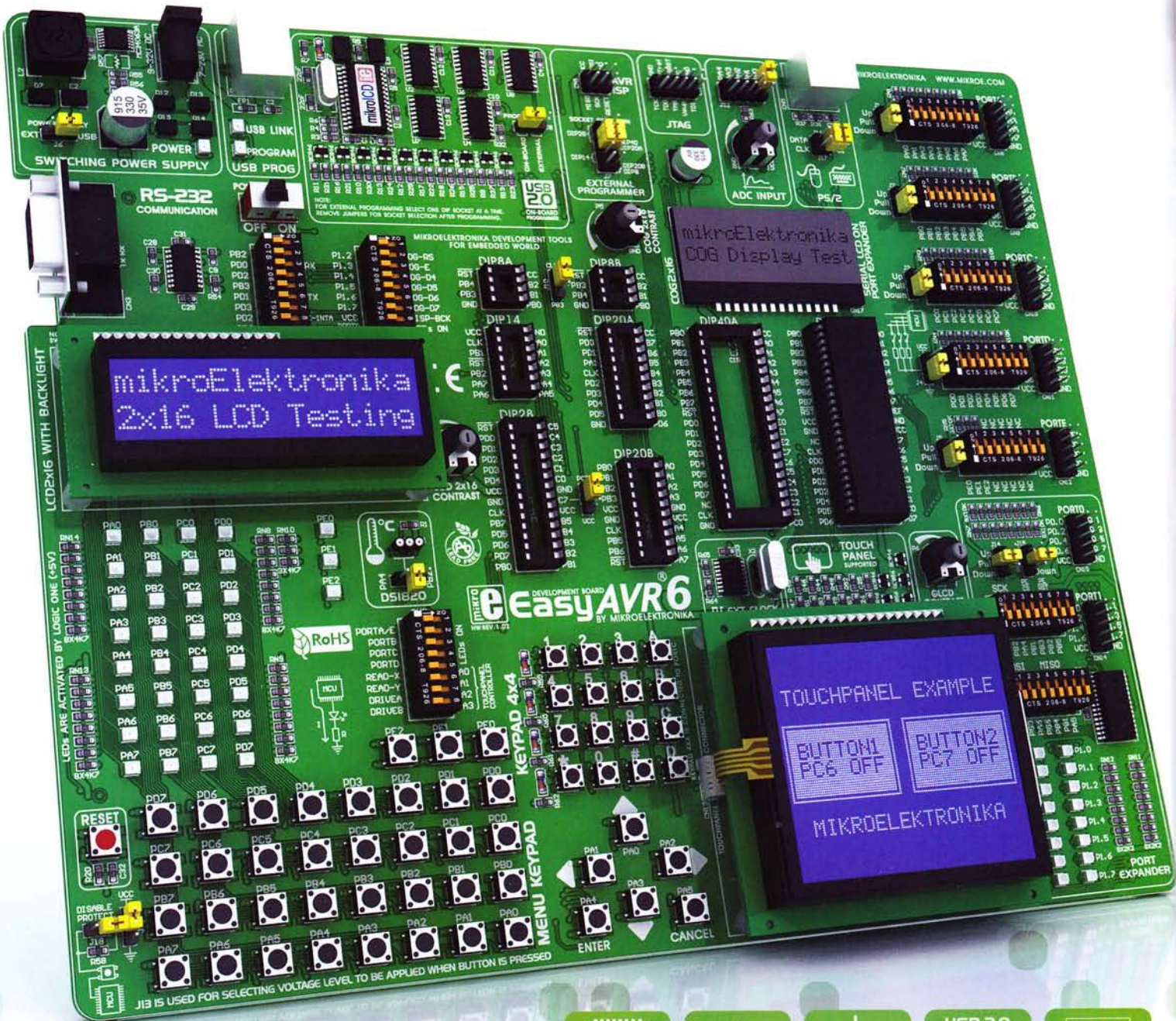

6 YEARS OF DEVELOPMENT SYSTEM IMPROVEMENT



The EasyAVR™6 development system is a development tool suitable for programming AVR® microcontrollers. This development system includes an on-board programmer providing an interface for programming microcontrollers using a PC. You are simply expected to write a code in one of the AVR® compilers, generate a .hex file and program your microcontroller using the AVRprog™ programmer. Numerous on-board modules, such as 128x64 graphic LCD, alphanumeric 2x16 LCD with serial communication, keypad 4x4, port expander etc., allow you to easily simulate the operation of the target device.

EXPERIENCE THE EASE OF CREATING YOUR OWN ELECTRONIC DEVICE WITH THE **EasyAVR™6**

**MikroElektronika**  
DEVELOPMENT TOOLS | COMPILERS | BOOKS

...making it simple

GET IT NOW  
[www.mikroe.com](http://www.mikroe.com)

**The RS EDP.  
No other platform can make  
your concepts fly quicker.**

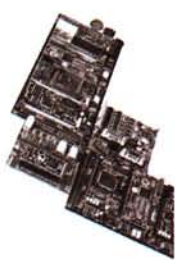
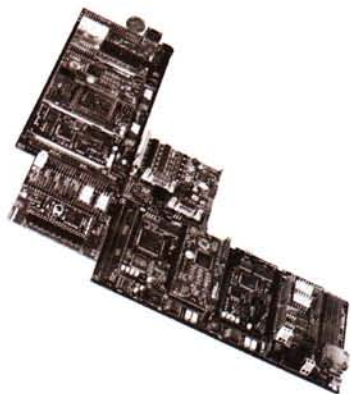
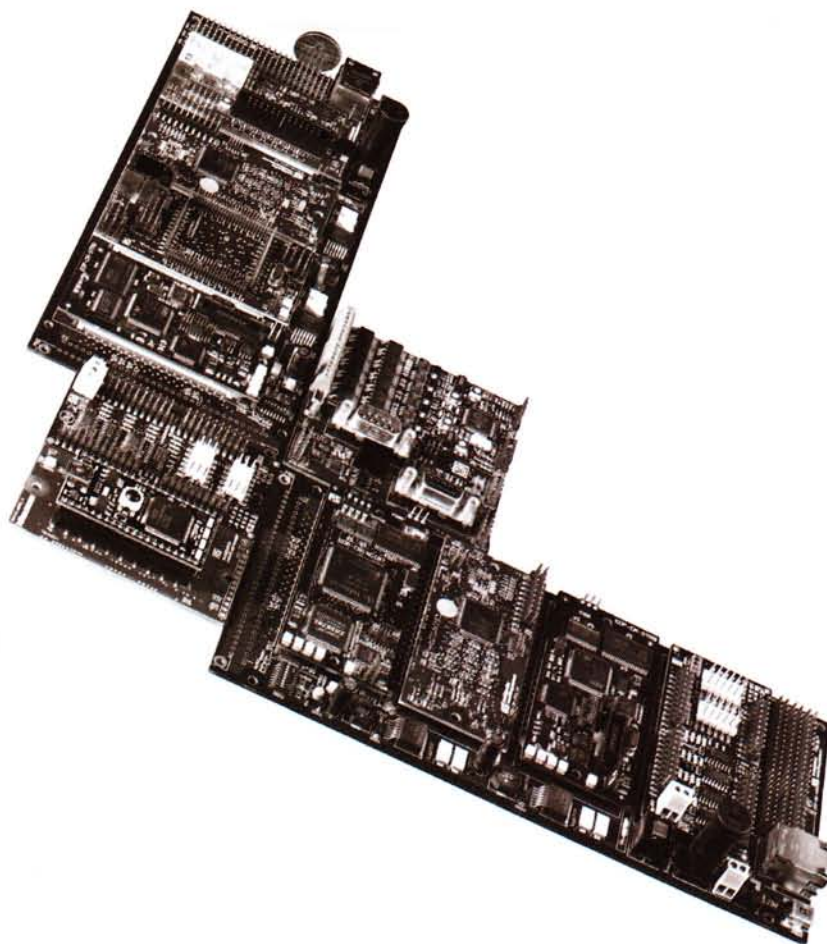

**EMBEDDED  
DEVELOPMENT  
PLATFORM**

[rswww.com/edp](http://rswww.com/edp) 08457 201201



## T&M is everywhere

If you look at a thousand electronic circuits, which is time consuming but painless by browsing, say, ten volumes of Elektor, it's not too difficult to pinpoint an aspect of test and measurement in at least five hundred. In some cases, it's there right in front of you: the audio amplifier requiring an ammeter to set up the quiescent current in the final stage; the latest microcontroller board with 12-bit ADC channels to hook up sensors (which are 'totally' measurement); or the linear power supply with its current sensing resistors somewhere telling the control circuit when to shut down the output voltage.

In other cases, you have to think harder to identify the "T&M" factor in a circuit or publication, and you might be inclined to say "none in this one" with some confidence. But do not forget your intuition as a powerful instrument for lots of measurements of the unscientific type. Personally I can never resist gauging the temperature a power transistor or a voltage regulator is running on its heatsink, simply by first sniffing the air above the heatsink and then — just maybe — touching the surface with my finger. No Pt100 probes or IR gun thermometer required — anything running above 40 celcius or so is ever so easy to spot. Another measurement completed to prevent trouble arising — coarse but okay.

In this edition of Elektor T&M is all over the place — in OBD, too. Your car is constantly measuring a hundred or so parameters to check for faults and if one occurs, flags an error code for reading out through the OBD interface. If you're an astute Elektor reader then surely you'll want to use the Elektor OBD analyser for that purpose — after all, you don't want to be taken for a ride by Joe from the garage down the block. With this month's OBD Mini Simulator (page 18) it's not necessary anymore to plug into a lot of cars with the Engine Failure light on, just to convince yourself that your OBD analyser is working properly, or indeed to learn to work with it. Safety is not just in numbers but in measurement results too.

Jan Buiting, Editor

- 6 Colophon**  
Who's who at Elektor magazine.
- 8 Elektor Foundation Awards 2010**
- 10 News & New Products**  
A monthly roundup of all the latest in electronics land.
- 16 Energy from the Internet, Water and ICs**  
We discovered some unexpected sources of electrical energy you, too, might want to tap into to help save the planet.
- 18 OBDz Mini Simulator**  
A chicken and egg problem ended: this simulator will tell for sure if your OBD analyser is working properly — with no car around.
- 24 Wireless Electricity meets RFID**  
An end to the myth held up by professionals saying you can't make your own RFID readers, personalized tags, or an RFID system to transfer energy.
- 32 High Speed Flash Trigger**  
Here's how the Elektor ATM18 board takes control of ultra-fast photo flashing for events requiring high time resolution.
- 36 DMX512 Control Interface**  
Based on a Cypress PSoc powerhouse this DMX512 controller has a mass of functionality and a sleek user interface, too.
- 43 Two USB scopes and one not so USB**  
USB oscilloscopes are all the rage. This month E-LABs examined three instruments, one low cost, one high end, and one with no USB and no PC connected — yes, it's stand alone!
- 46 Audio teamwork**  
E-LABs were called in to provide assistance with distortion measurements on a few high-spec audio amplifiers. Some quirky results!
- 48 Measuring for Free**  
Why buy expensive test equipment if

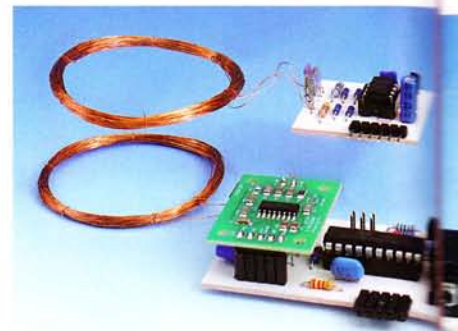
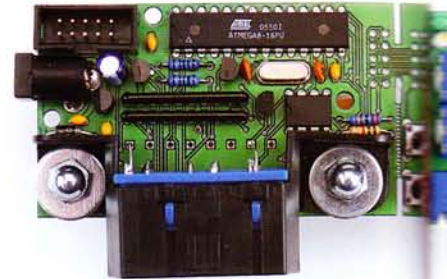

# CONTENTS

Volume 36  
June 2010  
no. 402

## 18 OBD2 Mini Simulator

OBD testing on a real vehicle can be a little uncomfortable especially if you don't have the option of working in a garage. The MiniSim simulates the signals that you would normally expect to encounter when you plug an OBD analyser into your vehicle's OBD2 connector. This allows you to carry out testing and development of a new analyser design from the comfort of your own lab bench.

## 24 Wireless Electricity meets RFID

RFID tags based on the EM4102 chip are cheap, even in small quantities, and readily available. In this project we use a small printed circuit board with the EM4095 reader IC mounted on it, which allows you to transfer the data from the RFID tag to an ATM18 test board. The reader board can also be used to make an RFID reader using an ATtiny2313.

## 36 DMX512 Control Interface

The DMX512 protocol is a professional standard for controlling lighting equipment. However, truly general-purpose DMX driver interfaces are far from cheap. This circuit provides a wide variety of outputs and is based on a Cypress PSoC device that supports visual configuration. This makes it very easy to generate the desired setup for lighting systems.

## 48 Measuring for Free

Most of you will be aware that an oscilloscope and a function generator are required for in-depth investigation of electronics circuits. However, using a PC and some free software you can have this functionality for low frequency measurements, without having to buy 'real' test equipment.

your PC, a good soundcard and some free software are just fine for many measurements in the audio frequency range?

### 52 LiPo AutoBalancer

Here we get to grips with 2s, 3s and 4s Lithium Polymer battery packs and the need to balance their charging process.

### 58 Intersceptre opens doors (and ports!) for you

Fast, convenient prototyping of sophisticated microcontroller applications becomes a reality with this multi-platform extension board.

### 64 Starry Night

This unique celestial slide show displays the major constellations using an MSP430 microcontroller. Fully configurable and expandable it's sure to be a talking point.

### 68 Alternative HiFi Power Supplies

Here we examine if those dirt cheap switch-mode power supplies from China etc. are any good for serious audio applications.

### 71 My Friend the Accelerometer

Stick an accelerometer device onto a loudspeaker cone, add a suitable preamplifier and you have a tool of the trade for advanced acoustic measurements. Ed Simon explains.

### 74 Design Tip: Mini dice

A PIC and a few LEDs make a dice circuit that does really well in terms of randomness.

### 76 Hexadoku

Our monthly puzzle with an electronics touch.

### 77 Retronics: elekterminal (1978)

Regular feature on electronics 'odd & ancient'. Series Editor: Jan Buiting

### 84 Coming Attractions

Next month in Elektor magazine

Elektor International Media provides a multimedia and interactive platform for everyone interested in electronics. From professionals passionate about their work to enthusiasts with professional ambitions. From beginner to diehard, from student to lecturer. Information, education, inspiration and entertainment. Analogue and digital; practical and theoretical; software and hardware.

Volume 36, Number 402, June 2010 ISSN 1757-0875

Elektor aims at inspiring people to master electronics at any personal level by presenting construction projects and spotting developments in electronics and information technology.

**Publishers:** Elektor International Media, Regus Brentford, 1000 Great West Road, Brentford TW8 9HH, England. Tel. (+44) 208 261 4509, fax: (+44) 208 261 4447 www.elektor.com

The magazine is available from newsagents, bookshops and electronics retail outlets, or on subscription. Elektor is published 11 times a year with a double issue for July & August.

Elektor is also published in French, Spanish, American English, German and Dutch. Together with franchised editions the magazine is on circulation in more than 50 countries.

**International Editor:** Wisse Hettinga (w.hettinga@elektor.nl)

**Editor:** Jan Buiting (editor@elektor.com)

**International editorial staff:** Harry Baggen, Thijs Beckers, Eduardo Corral, Ernst Krempelsauer, Jens Nickel, Clemens Valens.

**Design staff:** Antoine Authier (Head), Ton Giesberts, Luc Lemmens, Daniel Rodrigues, Jan Visser, Christian Vossen

**Editorial secretariat:** Hedwig Hennekens (secretariaat@elektor.nl)

**Graphic design / DTP:** Giel Dols, Mart Schroyen

**Managing Director / Publisher:** Paul Snakkers

**Marketing:** Carlo van Nistelrooy

**Subscriptions:** Elektor International Media, Regus Brentford, 1000 Great West Road, Brentford TW8 9HH, England. Tel. (+44) 208 261 4509, fax: (+44) 208 261 4447 Internet: www.elektor.com/subs

**NEW!**

# DVD Masterclass High-End Valve Amplifiers



Specifically for audio designers, audiophiles, DIY enthusiasts etc.



In this Masterclass Menno van der Veen will examine the predictability and perceptibility of the specifications of valve amplifiers. Covered are models that allow the characteristics of valve amplifiers to be explored up to the limits of the audible domain from 20 Hz to 20 kHz. This then leads to the minimum stability requirements that the amplifier has to satisfy. The coupling between output valves and output transformer are also modeled.

**Including:**

- 3.5 hours of Video material
- PowerPoint presentation (74 slides)
- Scanned overhead sheets (22 sheets)
- AES Publications mentioned during the Masterclass

**Contents:**

**Part 1 Preamplifiers**

Equivalent schematics, limits in the frequency.

**Part 2 Power amplifiers**

Modeling of class A to B, interaction of the specifications for Output Transformers (OPTs) and frequency range and damping factor.

**Part 3 Negative feedback**

How negative feedback can be done right, remarkable experiments in the project.

**Part 4 Output transformers**

Limitations and possibilities of the output transformer.

**BONUS:**  
25 Elektor publications  
about valves

ISBN 978-0-905705-86-6 • £24.90 • US \$40.20

**elektor**

Further information and ordering at  
[www.elektor.com/shop](http://www.elektor.com/shop)

Email: [subscriptions@elektor.com](mailto:subscriptions@elektor.com)  
Rates and terms are given on the Subscription Order Form.

Head Office: Elektor International Media b.v.  
P.O. Box 11 NL-6114-ZG Susteren The Netherlands  
Telephone: (+31) 46 4389444. Fax: (+31) 46 4370161

Distribution:  
Seymour, 2 East Poultry Street, London EC1A, England  
Telephone: +44 207 429 4073

UK Advertising:  
Huson International Media, Cambridge House,  
Gogmore Lane, Chertsey, Surrey KT16 9AP, England.  
Telephone: +44 1932 564999, Fax: +44 1932 564998

Email: [r.elgar@husonmedia.com](mailto:r.elgar@husonmedia.com)  
Internet: [www.husonmedia.com](http://www.husonmedia.com)  
Advertising rates and terms available on request.

**Copyright Notice**  
The circuits described in this magazine are for domestic use only. All drawings, photographs, printed circuit board layouts, programmed integrated circuits, disks, CD-ROMs, software carriers and article texts published in our books and magazines (other than third-party advertisements) are copyright Elektor International Media b.v. and may not be reproduced or transmitted in any form or by any means, including photocopying, scanning or recording, in whole or in part without prior written permission from the Publisher. Such written permission must also be obtained before any part of this publication is stored in a retrieval

system of any nature. Patent protection may exist in respect of circuits, devices, components etc. described in this magazine. The Publisher does not accept responsibility for failing to identify such patent(s) or other protection. The submission of designs or articles implies permission to the Publisher to alter the text and design, and to use the contents in other Elektor International Media publications and activities. The Publisher cannot guarantee to return any material submitted to them.

**Disclaimer:**  
Prices and descriptions of publication-related items subject to change. Errors and omissions excluded.

© Elektor International Media b.v. 2009 Printed in the Netherlands

## Truly unique: the Elektor Foundation Awards 2010

Elektor handed out the first Elektor Foundation Awards last year. In a simple and straightforward event, we highlighted the activities of a number of people and companies. People who carry their passion for electronics further than most and who give it special form in rescue operations, stimulating education and learning, and sustainable projects, to mention a few examples. The awards ceremony honours the more than 250,000 readers and sponsors in the many countries where Elektor is active. Although no monetary prize is associated with the awards, the Foundation and the awards

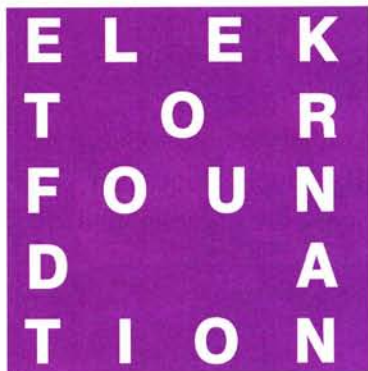

### Elektor Foundation

are open to electronics companies that wish to sponsor a category or wish to assist a winner with money, good advice, products or services.

The directors of the Elektor Foundation and Elektor's international editorial staff collaborate closely in the selection and nomination process and granting of the awards. For instance, the first round of the selection process is based in part on suggestions from Elektor readers. This year the selection categories for the Elektor Awards are 'unique design' (an electronics project with a unique design or approach), 'unique learning' (which encompasses unique study projects, courses of study or teachers), and 'unique & sustainable' (how electronics helps improve our world).

If you have any ideas or suggestions regarding people or organisations that in your view deserve an Elektor Award in 2010, please send a short e-mail message to [Award2010@elektor.com](mailto:Award2010@elektor.com). Naturally, you may also send a message to the Editor at [editor@elektor.com](mailto:editor@elektor.com). If you wish to sponsor an Elektor Award or assist a winner in his or her good work, please contact Sponsor Manager Don Akkermans by e-mail at [don.akkermans@elektorfoundation.org](mailto:don.akkermans@elektorfoundation.org).

## The road to India, Turkey and South Africa

For several years now, we have been receiving requests to initiate activities in India. With the signing of a contract with the firm Esskay in Mumbai, we have now taken the first step towards launching Elektor activities in India. During the coming months we will work on developing a website, publications and products. We are fully confident that these products will appear on the market before the end of the year. If you wish to stay on top of developments and have a front-row seat, please let us know at [Elektorindia@esskay.in](mailto:Elektorindia@esskay.in). Naturally, this also applies to companies inside or outside India. We also expect to commence Elektor activities in Turkey in the near future. There's a whole lot going on in this enormous country, and we hope to foster a new generation of electronics enthusiasts there with our Elektor products. The same applies to South Africa. With



India is coming to Elektor — Elektor is coming to India

India, South Africa and Turkey, Elektor will then be active in fourteen countries, including Germany, the Netherlands, England, France, Spain, Portugal, Brazil, Italy, Sweden, and the United States.

## Lust for (Elektor) Lifve!

The third edition of the Elektor Live! event will be held in the Netherlands on 20 November 2010. The venue is the former Philips exhibition hall Evoluon in Eindhoven. In this fantastic building, which resembles a giant UFO on the ground, you can look forward to a day jam-packed with demos, workshops and hands-on sessions dealing with everything related to the subject of electronics. This year Elektor Live! features a very interesting morning seminar pro-



gramme. Seminar participants will receive three hours of instruction on specific hardware, development boards or a particular technology. So far we have (provisionally) lined up NXP, Matrix Multimedia, Muvium, Altium Transfer and eQuip as seminar presenters. There is a fee for participation, and participants may take home the lesson material (hardware, software, etc.). After three hours, you'll be your own expert!

It's all happening ... @Elektor

Wisse Hettinga





## Link cellphones and PDAs compatibles with USB memory devices

Mobidapter, newly introduced by Saelig Company, Inc., is a USB memory stick reader which plugs directly into the SD memory slot on mobile/cell phones, smart phones and PDAs, permitting — for the first time — reliable, rapid transfer of files from USB sources. Just insert Mobidapter to a phone's SD slot, connect it to a USB memory device, and — in an instant — text files, images, PowerPoint files, can be e-mailed. Now files can be transferred anywhere, without a PC, in all operating systems since no drivers are required.



USB memory sticks have become the de facto way to carry and transfer data, but until now it has been impossible to connect them to mobile phones and PDAs. Mobidapter works with any make of mobile/cell phone, SmartPhone or PDA that features an external SD socket. It can also be used with mini-SD sockets using simple adapter. Both SD and SDHC hosts are supported. In effect, Mobidapter becomes a standard USB host connector, interfacing with USB memory devices to a maximum 32 GB.

Mobidapter can be used with many other devices, such as TVs, PDAs, GPS devices and Digital Picture Frames. It is now possible to transfer data such as pictures, MP3 files, Microsoft Office applications, or any type of file from a standard USB memory stick to and from a mobile device. Last minute data sent from head office while you are in the field, but no Internet access? No problem! Download it via your cellphone to a memory stick (and hence your laptop) using Mobidapter.

Mobidapter is compatible with virtually all of the latest phones with an external SD memory slot and all standard USB memory sticks. Power is provided from the host device so no batteries are needed. Applications include: instant transfer of images, music and data between phones, PDAs, MP3/4 players from any location; data backups; work files, etc.

Mobidapter is available now from \$59.00 each directly from Saelig Company Inc., Pittsford NY. In the UK, please contact IOStore.

Mobidapter is available now from \$59.00 each directly from Saelig Company Inc., Pittsford NY. In the UK, please contact IOStore.

[www.saelig.com](http://www.saelig.com)    [www.elandigitalsystems.com/adapt er/mobidapter.php](http://www.elandigitalsystems.com/adapt%20er/mobidapter.php)    [www.iostore.co.uk](http://www.iostore.co.uk)  
(100266-XII)

## Next-generation multi-standard video decoder solution for HDTV set-top boxes

Fujitsu Microelectronics Europe recently launched its next-generation high-definition (HD) multi-standard video decoder solution. The MB86H61 complies with the Digital Video Broadcasting (DVB) and China Audio and Video Coding (AVS) Standards. The decoder chip is capable of decoding MPEG-2, H.264/AVC, AVS and VC-1 compressed video up to HD resolution. It combines a fast ARM1176JZF-S™ CPU with more than 475 DMIPS with all the features required by next-generation HDTV receivers including advanced security for support-

ing CI-Plus and the latest embedded Conditional Access (CA) systems.

This cost-effective, low power and highly integrated System-on-Chip (SoC) incorporates all the necessary processing functions for digital video, digital audio, powerful on-screen graphics and a variety of connectivity options for set-top boxes (STB), personal video recorders (PVR) and in-car TV receivers. With the included stand-by controller, it adheres to The European Code of Conduct on Energy Efficiency and enables customers to realise STBs with extremely low power

consumption. The integrated PHYs for SATA and two USB ports allow for cost-effective product designs. Additional system benefits include support for low-cost, high-speed DDR2 and NAND flash technologies.

A significant part of this new HDTV video decoder solution is the comprehensive STB application software including drivers, middleware and a customisable user interface. The software package includes ports for various third party software IPs for digital TV functions such as MHEG-5, DVB Teletext/Subtitles and CI-Plus. With its application teams located in Europe, China and Japan, Fujitsu Microelectronics is capable of providing excellent local support to its customers helping them to design their next-generation digital TV products.

The DVB digital broadcasting standard is used in Europe, Russia, the Middle East, and by some broadcast systems in China



that broadcast in standard definition (SD) and high-definition using the MPEG-2 and H.264 video compression formats.

The AVS specification provides one of the most comprehensive standardisation solutions for the Chinese digital video and audio industry because it addresses system level content transport, video/audio coding formats and media copyright management. It also provides video coding efficiency that is two-to-three times more efficient than MPEG-2 (and equivalent to H.264).

<http://emea.fujitsu.com/microelectronics>  
(100266-XV)

## Compact base station analyzer to provide coverage up to 6 GHz

Anritsu Company introduces the Cell Master MT8213E, the most compact handheld base station analyzer to provide frequency cover-

age up to 6 GHz. Combining excellent noise and RF performance, and 10 MHz demodulation bandwidth in a compact, lightweight design, the MT8213E is ideal for cell site technicians who need to accurately and quickly test and verify the performance of installed 2G/3G/4G networks, including LTE, GSM/EDGE, W-CDMA/HSDPA, WiMAX, and CDMA/EV-DO.

The Cell Master MT8213E continues the tradition of Anritsu's "E" platform, a new generation of handheld field instruments that features integrated functionality in a robust, lightweight, field-proven design that provides all the tools necessary to deploy, maintain, and troubleshoot today's most demanding wireless equipment and networks. The Cell Master MT8213E integrates a 6-GHz two-port cable and antenna analyzer and 6-GHz spectrum analyzer, as well as a power meter, interference analyzer, channel scanner, and T1, E1, and T1/T3 backhaul analyzers.

Field technicians can conduct a full suite of measurements with the Cell Master MT8213E. Among the cable and antenna tests that can be made are RL, VSWR, Cable Loss, distance-to-fault (DTF), phase, and power. Sweep speed is typically 1 msec/data point.



When in spectrum analyzer mode, users can measure occupied bandwidth, channel power, ACPR, and carrier-to-interference ratio (C/I). Cell Master MT8213E can also provide spectrograms, signal strength, RSSI, and signal ID. The analyzer has dynamic range of >95 dB in 10 Hz RBW, DANL of -152 dBm in 10 Hz RBW, and phase noise of -100 dBc/Hz max @ 10 kHz offset at 1 GHz.

The analyzer's day light viewable 8.4-inch touchscreen allows users to display results in single- or dual-mode for more thorough analysis capability. It has two USB ports that provide the convenience of exporting measurement data to a flash drive while a power sensor is connected to the analyzer.

As with all Anritsu handheld analyzers, the Cell Master MT8213E has been designed to withstand the rigors of the field environment and is extremely lightweight, weighing only 8.2 lbs.

Cell Master MT8213E is compatible with Anritsu's Master Software Tools (MST). A powerful PC software post-processing tool

designed to enhance the productivity of technicians, MST allows acquired data to be easily transferred to a computer for report generation, data analysis, and testing automation. Measurements can be saved as .DAT and are compatible with HHST.

[www.anritsu.com](http://www.anritsu.com) (100266-XVI)

## Smart contact lens with embedded wireless sensor helps glaucoma diagnosis treatment

STMicroelectronics has announced that it will develop and supply a wireless MEMS sensor that acts as a transducer, antenna and mechanical support for additional read-out electronics in a breakthrough platform developed by Swiss company Sensimed AG. This solution will enable better management of glaucoma patients via earlier diagnosis and treatment that is optimally tailored to the individual patient.

Known as the SENSIMED Triggerfish®, the solution is based on a 'smart' contact lens that uses a tiny embedded strain gauge to monitor the curvature

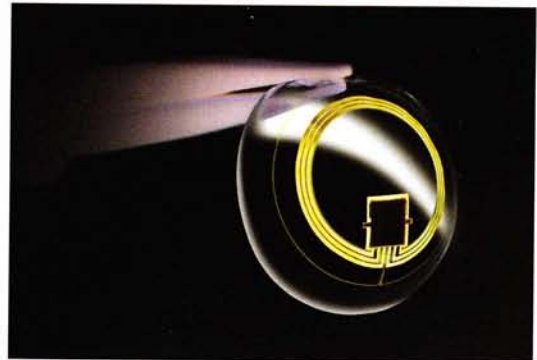

of the eye over a period of, typically, 24 hours, providing valuable disease management data that is not currently obtainable using conventional ophthalmic equipment.

Glaucoma3, the second most common cause of blindness around the world, is an irreversible progressive disease of the optic nerve that can eventually lead to blindness. Although it cannot be cured, its progress can be controlled once it is diagnosed and treated properly. The standard test is the measurement of intraocular pressure (IOP), using an instrument known as a tonometer, during periodic visits to an ophthalmologist. However, the tonometer may fail to detect an elevated IOP, especially in glaucoma patients, because the pressure varies during the day and often peaks during sleep or outside of office hours. As a result, the disease is often diagnosed only after significant damage to the optic nerve has already occurred, and the disease keeps progressing in many patients due to inadequate treatment.

Sensimed's ingenious solution is a two-part system comprising the smart contact lens and a small receiver worn around the patient's neck. In addition to the strain gauge the lens contains an antenna, a tiny dedicated processing circuit and an RF transmitter to communicate the measurements to the receiver. The lens is powered via the received radio waves and does not need to be connected to a battery. The embedded components are positioned in the lens in such a way that they do not interfere with the patient's vision. The lens is fitted by the ophthalmologist and when the patient returns the next day the ophthalmologist removes the lens and receiver, obtaining a complete record of IOP changes over the preceding 24 hours.

ST engineers are now working with Sensimed to translate this breakthrough technology into a reliable commercial MEMS product ready for mass production. ST expects the development of the MEMS sensor to be completed in Q2 2010 and manufacturing to start in Q3 2010, with availability outside trials to doctors and patients subject to regulatory approvals. Sensimed and ST anticipate progressively rolling out the product country-by-country across Europe beginning in Q3 and entering the US market by the end of 2011.

[www.st.com](http://www.st.com) (100266-XIII)

## Pico's new 12 GHz TDR/TDT sampling oscilloscope

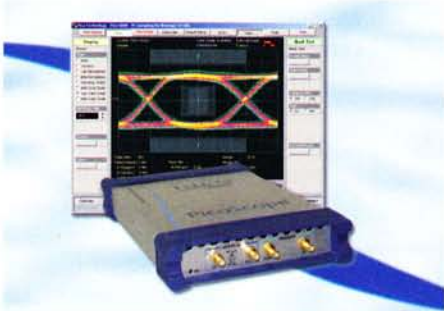

The PicoScope 9211A TDR/TDT Sampling Oscilloscope is a new instrument specially designed for time-domain reflectometry (TDR) and time-domain transmission (TDT). It provides a low-cost method of analysing cables, connectors, circuit boards and IC packages.

The PicoScope 9211A works by stimulating the device under test using its two independently programmable, 100-ps (typical) rise-time step generators. It then uses its 12 GHz sampling inputs to build up a picture from a sequence of reflected or transmitted pulses. The results can be displayed as volts, ohms or reflection coefficient against time or distance.

As well as TDR/TDT analysis, the PicoScope 9211A can also be used for mask limit testing of a wide range of communications standards including SONET/SDH, Fibre Channel, Ethernet, InfiniBand 2.5G and 5.0G, XAUI, ITU G.703, ANSI T1/102, RapidIO 1.25G and 3.125G, G.984.2, PCI Express 2.5G and 5.0G, and Serial ATA 1.5G and 3.0G. Over 150 industry-standard masks are included. The instrument has three trigger inputs — a DC to 1 GHz direct trigger, a 1 to 10 GHz prescaled trigger and a 12.3 Mbps to 2.7 Gbps clock-recovery trigger — as well as a 10 Gbps pattern sync trigger for averaging eye diagrams.

Unlike traditional, bulky bench-top instruments that contain a PC and a display, the PicoScope 9211A takes very little space on your workbench. If you're working at a customer's premises, the only extra equipment you need to carry is a laptop and a mains adapter. The analyser connects to any Windows XP or Vista computer with a USB 2.0 port, and an Ethernet port is provided for remote operation over a network. There are no extra software modules to buy.

The PicoScope 9211A is on sale now, priced at £7,495. The price includes all necessary calibrated cables, filters, power splitters and adaptors.

[www.picotech.com](http://www.picotech.com) (100266-XVII)

## Extruded aluminium Eurocard cases

Vero Technologies has introduced three styles of extruded aluminium instrument cases, designed to accept three quarter and full width Eurocard PCBs. Circuit boards are mounted horizontally into multi-position internal slots in the body of the case, which has a black anodised finish for good resistance to wear and tear and improved heat dissipation. The smaller three quarter width E003 range is 40 mm in height and will accept a 75 mm wide PCB into four PCB slot positions; the larger E005 and E006 are 61 mm high and will take standard 100 mm wide Eurocards into eight PCB slot positions. The external surface of the enclosure incorporates a series of ribbed fins to aid heat dissipation and T slots are provided on both sides and the base to enable the units to be securely attached to other equipment if required. For enhanced access, the E006 full width units have a removable aluminium top cover; all sizes are supplied with two flat aluminium end panels.



Each of the three families is available in lengths of 100, 125, 165, 200, 225 and 285 mm as standard; other lengths are available to order. Alternative finishes to the standard black anodised can be specified and all sizes can be factory machined with holes, slots, cut-outs and apertures in the body and end panel to meet specific customer requirements and an option neoprene gasket sealing kit gives protection to IP65 if required.

[www.verotl.com](http://www.verotl.com) (100266-XI)

## PowerBurst® PC5 ultracapacitor

Tecate's PowerBurst® Type PC5 ultracapacitor is engineered to provide extended power availability during dips, sags, and

outages in the main power sources as well as to relieve batteries of burst power functions. The RoHS-compliant part's flat prismatic cell design notably incorporates stainless steel, hermetically sealed cells. Due to this unique construction, it boasts an extremely low profile (5.1 mm max.) making it an excellent choice for space constrained applications. The low ESR (Equivalent Series Resistance) PC5 ultracapacitor is capable of accepting charges at the identical rate of discharge, and features accessible terminals and an electrostatic storage capability to facilitate over 500,000 duty cycles and a 10-year life capability.

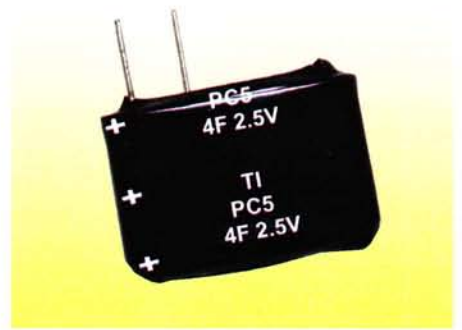

Tecate's PowerBurst Type PC5 ultracapacitor is commonly specified for employment in a broad range of applications including providing, holding up, or bridging power until the back-up power source 'kicks in' when the primary power source fails. Its back-up power capabilities make it well suited for soft shutdown, 'last gasp' notification, battery swaps, and memory retention. In addition, the PC5 is used in tandem with batteries or other power sources where batteries alone do not meet performance objectives. The small form factor part is highly appropriate in military and consumer electronics, wireless transmission, medical devices, automatic meter readers (AMRs), solid state drives (SSDs), smart grids, RAID (Redundant Array of Independent Disks) controllers, handheld GPS devices, and remote sensors. Its utilization often enables designers to downsize the primary system batteries.

The radial-leaded ultracapacitor has a small 14 mm (L) x 23.6 mm (W) x 4.8 mm (W) footprint, and very low, 5.1 mm profile. Standard parts feature a voltage of 2.5 VDC, capacitance of 4.0F, and an extended temperature range of from -40 degrees to +70 degrees C. Capacitance tolerance is ±20%.

[www.tecategroup.com](http://www.tecategroup.com) (100266-XIV)



## VoiceGP voice recognition development tools

TIGAL recently launched their VoiceGP family of products under its Veeear brand of voice and speech recognition products. The VoiceGP family includes all the hardware and software required for easy and cost effective development and implementation of speech synthesis and multi-language speaker independent and speaker dependent speech recognition capabilities to virtually any application. The product family consists of the VoiceGP Module and two Development Kits with bundled Development Software.

The VoiceGP Module is based on Sensory's RSC-4128 mixed signal processor. Its small size of 42mm x 72mm and two 28-pin connectors with 2.54 mm pin spacing make it breadboard friendly and suitable for prototype boards. The module is capable of running the latest Sensory FluentChip™ core technology libraries which enable speaker dependent recognition in any language, speaker independent recognition (US/UK English, German, French, Italian, Spanish (Latin American), Japanese and Korean), Speech, DTFM Synthesis, Speaker Verification, and Record and Play. The module has 512 KB of Code/Const Flash, 512 KB of Serial Data Flash, 128 KB External RAM, and enables full access to the I/O pins of the RSC-4X processor. It also features an expansion bus that allows fast SPI interface to MMC cards, 5 dedicated chip select outputs, 2 memory enable outputs and an 8-bit wide read-write memory bus.

The VoiceGP Development Kit includes the VoiceGP module and a Development Board that can be powered via USB, batteries or an external power supply. It also has an on-board USB / Serial adapter and programmer, on-board microphone, selectable audio output (PWM or DAC with on-board amplifier), 4 push-button inputs and 4 LED outputs for demos and fast prototypes,

## ElneC: new extremely fast BeeProg2 Universal Programmer

ElneC, manufacturer of Europe's leading Device Programmers, has recently released a new 48-pin universal programmer which currently supports more than 52,000 devices. Since programming times are faster than ever before, this new product will appeal not only to the community of hardware developers, but also to small and medium sized manufacturers.

The BeeProg2 is an enhanced version of the popular BeeProg+ universal programmer (in daily use at Elektor Labs). The company's target was to optimize this product for fast programming of high density memories which has been achieved through the use of a much more powerful FPGA based core inside the programmer. The BeeProg2 is able to program NAND and NOR Flash memories up to 70% faster than its predecessor.

The programmer is a perfect solution for both developers and manufacturers who program devices in higher quantities. It reliably programs a wide range of programmable chips in the ZIF socket (more than 800 models of socket converters are available) as well as through the ISP connector. ElneC's programmer software allows up to eight BeeProg2 programmers or its predecessors (BeeProg+/BeeProg) to be connected and operated from one PC making for a very flexible production solution. Furthermore, as a whole it works as a concurrent multiprogramming system. As a result, each programmer can work independently and when necessary, program different types of chip. This solution saves user's time and also funds needed for staff and hardware.

The BeeProg2 is not only a programmer, but also a tester of TTL/CMOS logic ICs and memories. In addition, the programmer performs device insertion tests (wrong or backward position) and contact checks (poor contact pin-to-socket) before it programs each device. These capabilities, supported by overcurrent protection and signature-byte check, minimize the possibility of chip damage due to operator error.

As mentioned earlier, the programming speed increase for serial and parallel NAND and NOR Flash memories means, in absolute numbers, that the BeeProg2 can program and verify a 64 Mbit NOR Flash in less than 13s and program and verify NAND Flash of the same size in less than 123s. The BeeProg2's programming times are comparable to competing programmers claiming to offer "ultra-fast programming speed" and costing up to 50% more. ElneC continues its tradition of manufacturing high quality products and provides a unique worldwide 3 year warranty with this programmer.



[www.elnec.com](http://www.elnec.com)

(100346-1)

and an SD/SDHC/MMC compatible socket for extended storage. The bundled development software consists of an Integrated Development Environment, a tool chain with VeeSee C language code translator, VeeSee integrated C pre-processor, resource compiler and linker and VeeLoader code downloader / flash programmer. Sensory's FluentChip™ Technology Library (build tools and documentation) and Sensory's QuickSynthesis4™ software for speech and audio compression are also included. The kit is also optionally available with a user license for Sensory's Quick T2SI™ software that allows quick development of Speaker

Independent vocabularies from text-based input in multiple languages.

The VoiceGP Development Kits are shipped with the VoiceGP Module, VoiceGP Dev-Board, Software CD and a USB Cable. The VoiceGP Module is also available separately. All products are available directly from TIGAL or your local distributor. The VoiceGP DK, VoiceGP DK-T2SI and VoiceGP Module are priced at £149, £299 and £45 respectively, with discounts available at higher volumes. All software tools (except QT2SI), documentation and demo videos are available online as a free download.

[www.veear.eu](http://www.veear.eu)

[www.tigal.com](http://www.tigal.com)

## New custom front panel service

Having pioneered the facility for engineers to purchase PCBs online (pcb-pool.com), Beta LAYOUT has announced the introduction of a new online FRONT PANEL service.

This new service enables users to configure their own Front Panel designs and place an order directly



online. As well as providing a professional "free-to-download" Design Software, numerous machining options, material thickness, fonts, colours, & finishes are available.

The free, easy-to-use, Design Software simplifies the configuration and ordering of custom Front Panels. You can choose from many standardised construction units (e.g. ventilators, sub connectors) which are available in the software's library. The software even calculates the price of the finished Front Panels for you. Once your Front-Panel design is complete, an order can be placed directly through the software itself.

Alternatively DXF files from any CAD program can be converted and processed for a small surcharge. Separate printing & inscription files are required for this option.

Various Front Panel materials can be selected from a wide range of natural or coloured anodized aluminium and plastic (acrylic). Material thickness from 1.5mm to 3mm can be selected. The minimum dimensions possible are 30mm x 30mm, up to a maximum of 300mm x 460mm. High precision CNC machining, such as drilling (with and without threads), countersunk drills, flat milling and cut-outs are all possible. Ultra-modern milling and drilling machines are used to complete the manufacturing process. The inscription of Front Panels with text, logos, images, scalings etc. is achieved using engraving methods and/or high-resolution digital printing. The maximum order quantity is 50 pieces; lead-times are available from 3 to 8 working days.

[www.panel-pool.com](http://www.panel-pool.com)

(100346-III)

## Vinculum-II VNC2 evaluation modules

Future Technology Devices International (FTDI) have launched a range of VNC2 evaluation modules (V2DIP-x), a VNC2 evaluation kit (V2-EVAL) and a VNC2 debug module. These modules are designed to help designers quickly develop embedded USB 2.0 Host/Slave designs based on FTDI's recently announced Vinculum VNC2 devices. VNC2 is a user programmable dual USB 2.0 Host/Slave intelligent SOC controller featuring a customised 16-bit MCU core, 256 KByte e-Flash program memory and 16 KByte of SRAM data memory. VNC2, and its associated modules, are aimed at designers wishing to add USB connectiv-

ity while implementing their own custom application firmware.

The V2-EVAL evaluation kit is a complete prototyping platform for VNC2 and consists of a main development board which can take a 32, 48 or 64 pin daughter board to suit the VNC2 package selected. Two USB type 'A' connectors and a USB type 'B' connector provide interfacing, configuration and silicon level debug of the VNC2 application. A debug interface provides access through the USB interface to a comprehensive range of firmware debug features using the royalty-free Vinculum software development toolchain and Integrated Design Environment (IDE). The board provides I/O headers for all supported interfaces such as UART, FIFO, SPI



and GPIO. In addition, user configurable LEDs and switches are provided.

The V2DIP-x family is a range of compact VNC2 based USB Host/ Slave evaluation modules designed to fit into either a 0.6" or 0.8" standard DIP socket, allowing quick and easy connection to a development board or end product. Single (V2DIP1) or dual (V2DIP2) USB type 'A' connector versions are available for all 3 package sizes. VNC2 I/O pins are available via the DIP headers. In addition, a 6 pin header is provided to connect to the VNC2 Debug Module.

The VNC2 Debug Module, when used in conjunction with the Vinculum software development tool suite, provides full VNC2 silicon level debug. Connection to a host PC is provided via a USB type 'B' connector (and standard USB cable), while a 6 pin, 2 mm socket provides an interface to any of the V2DIP-x evaluation modules. Pricing for the modules, based on single unit quantities, are as follows: V2DIP1-48 \$21.50, V2DIP2-48 \$25.24, VNC2 DEBUG MODULE \$16.83, 2-EVAL \$79.00, V2-EVAL-EXT48 \$13.71 daughter board for use with V2-EVAL.

[www.ftdichip.com](http://www.ftdichip.com)

(100346-IV)

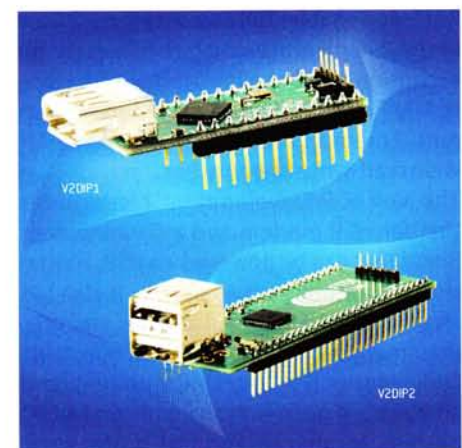



**QUASAR**  
electronics

The Electronic Kit Specialists Since 1993

**Quasar Electronics Limited**  
PO Box 6935, Bishops Cleeve  
CM23 4WP, United Kingdom  
Tel: 01279 467799  
Fax: 01279 267799  
E-mail: sales@quasarelectronics.com  
Web: www.quasarelectronics.com

**Postage & Packing Options** (Up to 0.5Kg gross weight): UK Standard 3-7 Day Delivery - £4.95; UK Mainland Next Day Delivery - £9.95; Europe (EU) - £8.95; Rest of World - £12.95 (up to 0.5Kg)  
**Order online for reduced price UK Postage!**  
We accept all major credit/debit cards. Make cheques/PO's payable to Quasar Electronics. Prices include 15.0% VAT.  
Please visit our online shop now for details of over 500 kits, projects, modules and publications. Discounts for bulk quantities.



**01279**

**Credit Card  
Sales**

**467799**

## Motor Drivers/Controllers

Here are just a few of our controller and driver modules for AC, DC, Unipolar/Bipolar stepper motors and servo motors. See website for full range and details.

### Computer Controlled / Standalone Unipolar Stepper Motor Driver

Drives any 5-35Vdc 5, 6 or 8-lead unipolar stepper motor rated up to 6 Amps. Provides speed and direction control. Operates in stand-alone or PC-controlled mode for CNC use. Connect up to six 3179 driver boards to a single parallel port. Board supply: 9Vdc. PCB: 80x50mm. Kit Order Code: 3179KT - **£15.95**  
Assembled Order Code: AS3179 - **£22.95**



### Computer Controlled Bi-Polar Stepper Motor Driver

Drive any 5-50Vdc, 5 Amp bi-polar stepper motor using externally supplied 5V levels for STEP and DIRECTION control. Opto-isolated inputs make it ideal for CNC applications using a PC running suitable software. Board supply: 8-30Vdc. PCB: 75x85mm. Kit Order Code: 3158KT - **£23.95**  
Assembled Order Code: AS3158 - **£33.95**



### Bi-Directional DC Motor Controller (v2)

Controls the speed of most common DC motors (rated up to 32Vdc, 10A) in both the forward and reverse direction. The range of control is from fully OFF to fully ON in both directions. The direction and speed are controlled using a single potentiometer. Screw terminal block for connections. Kit Order Code: 3166v2KT - **£22.95**  
Assembled Order Code: AS3166v2 - **£32.95**



### DC Motor Speed Controller (100V/7.5A)

Control the speed of almost any common DC motor rated up to 100V/7.5A. Pulse width modulation output for maximum motor torque at all speeds. Supply: 5-15Vdc. Box supplied. Dimensions (mm): 60Wx100Lx60H. Kit Order Code: 3067KT - **£17.95**  
Assembled Order Code: AS3067 - **£24.95**



Most items are available in kit form (KT suffix) or assembled and ready for use (AS prefix).

## Controllers & Loggers

Here are just a few of the controller and data acquisition and control units we have. See website for full details. Suitable PSU for all units: Order Code PSU445 £7.95

### 8-Ch Serial Isolated I/O Relay Module

Computer controlled 8-channel relay board. 5A mains rated relay outputs. 4 isolated digital inputs. Useful in a variety of control and sensing applications. Controlled via serial port for programming (using our new Windows interface, terminal emulator or batch files). Includes plastic case 130x100x30mm. Power Supply: 12Vdc/500mA. Kit Order Code: 3108KT - **£64.95**  
Assembled Order Code: AS3108 - **£79.95**



### Computer Temperature Data Logger

4-channel temperature logger for serial port. °C or °F. Continuously logs up to 4 separate sensors located 200m+ from board. Wide range of free software applications for storing/using data. PCB just 45x45mm. Powered by PC. Includes one DS1820 sensor. Kit Order Code: 3145KT - **£19.95**  
Assembled Order Code: AS3145 - **£26.95**  
Additional DS1820 Sensors - **£3.95 each**



### Rolling Code 4-Channel UHF Remote

State-of-the-Art. High security. 4 channels. Momentary or latching relay output. Range up to 40m. Up to 15 Tx's can be learnt by one Rx (kit includes one Tx but more available separately). 4 indicator LED's. Rx: PCB 77x85mm, 12Vdc/6mA (standby). Two and Ten channel versions also available. Kit Order Code: 3180KT - **£49.95**  
Assembled Order Code: AS3180 - **£59.95**



### DTMF Telephone Relay Switcher

Call your phone number using a DTMF phone from anywhere in the world and remotely turn on/off any of the 4 relays as desired. User settable Security Password, Anti-Tamper, Rings to Answer, Auto Hang-up and Lockout. Includes plastic case. Not BT approved. 130x110x30mm. Power: 12Vdc. Kit Order Code: 3140KT - **£74.95**  
Assembled Order Code: AS3140 - **£89.95**



### Infrared RC Relay Board

Individually control 12 on-board relays with included infrared remote control unit. Toggle or momentary. 15m+ range. 112x122mm. Supply: 12Vdc/0.5A. Kit Order Code: 3142KT - **£59.95**  
Assembled Order Code: AS3142 - **£69.95**



### New! 4-Channel Serial Port Temperature Monitor & Controller Relay Board

4 channel computer serial port temperature monitor and relay controller with four inputs for Dallas DS18S20 or DS18B20 digital thermometer sensors (£3.95 each). Four 5A rated relay channels provide output control. Relays are independent of sensor channels, allowing flexibility to setup the linkage in any way you choose. Commands for reading temperature and relay control sent via the RS232 interface using simple text strings. Control using a simple terminal / comms program (Windows HyperTerminal) or our free Windows application software. Kit Order Code: 3190KT - **£69.95**

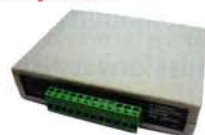

## PIC & ATMEL Programmers

We have a wide range of low cost PIC and ATMEL Programmers. Complete range and documentation available from our web site.

### Programmer Accessories:

40-pin Wide ZIF socket (ZIF40W) £14.95  
18Vdc Power supply (PSU120) £19.95  
Leads: Serial (LDC441) £3.95 / USB (LDC644) £2.95

### USB & Serial Port PIC Programmer

USB/Serial connection. Header cable for ICSP. Free Windows XP software. Wide range of supported PICs - see website for complete listing. ZIF Socket/USB lead not included. Supply: 16-18Vdc. Kit Order Code: 3149EKT - **£49.95**  
Assembled Order Code: AS3149E - **£59.95**

### USB 'All-Flash' PIC Programmer

USB PIC programmer for all 'Flash' devices. No external power supply making it truly portable. Supplied with box and Windows Software. ZIF Socket and USB lead not included. Assembled Order Code: AS3128 - **£49.95**



See website for full range of PIC & ATMEL Programmers and development tools.

**No.1  
KITS**



[www.quasarelectronics.com](http://www.quasarelectronics.com)

Secure Online Ordering Facilities • Full Product Listing, Descriptions & Photos • Kit Documentation & Software Downloads

# Energy from the Internet, Water and ICs

## Sustainability à la Elektor

By Wisse Hettinga (Elektor Editorial)

Let's make one thing clear: Elektor plays a minor and very modest role in the area of energy supply and sustainability. In fact, in our several decades of existence we have made a sizeable contribution to CO<sub>2</sub> emissions with our collection of test equipment and soldering irons. How can we make up for this?

Just because we play a minor role doesn't mean that we don't have an opinion on the subject of energy or sustainability. As always, if you're part of the problem you're also part of the solution. Here we present a small sampling of topics that we regard as 'typical Elektor'.

### Bloom Box: fact or fiction?

This development nearly escaped our notice. Fortunately, several prominent figures have devoted their attention to this company and engineered an enormous publicity campaign. Colin Powell (the Colin Powell) is a member of the company's Board of Directors, and the official launch of the power unit had a lot in common with an Apple product announcement. Even Arnold Schwarzenegger found time to attend the event and give it a bit of muscle. The people at Bloom Energy [1] certainly know how to attract atten-

tion, but their efforts have also drawn some critical comments. According to the company, the Bloom Box is a fuel cell developed on the basis of sand. I can almost hear whole populations thinking "well, there's certainly no shortage of sand", but this sand doesn't simply start generating energy by itself. The official designation is 'solid oxide fuel cell'. The sand is formed into tiles which are fired in an oven, a coating and an electrode are applied to each side, and there you have it: a compact fuel cell. Elektor's German editor Ernst Krempelsauer is an expert on fuel cell technology, and he sent us the following comments:

- Better CO<sub>2</sub> balance by using the waste heat, with an overall efficiency 94% (which is obviously not the case with Bloombox);
- Smaller, decentralized units (flexible, safe supply, existing funding model);
- Proven, durable and cost effective technology.

Received and acknowledged; thanks Ernst!

### The Pringles battery container

You can find a very special type of energy source in virtually every house. Let's call it the 'Pringles battery'. It's usually located in the pantry, and it slowly accumulates energy in the form of countless discarded batteries. Curious as ever, Elektor drew up a list of simple questions about this type of battery, such as: How many batteries are there in a typical Pringles can? How much do they weigh? What's the composition of the contents? How can we find out how much energy is contained in a typical Pringles battery? The results are: 25 AA cells, 14 AAA cells, two 9-V batteries, three heavy-duty 1.5-V cells, 14 button cells, and another 25 leaky batteries in all of the previously mentioned shapes and sizes.



## Bloomenergy



tion, but their efforts have also drawn some critical comments. According to the company, the Bloom Box is a fuel cell developed on the basis of sand. I can almost hear whole populations thinking "well, there's certainly no shortage of sand", but this sand doesn't simply start generating energy by itself. The official designation is 'solid oxide fuel cell'. The sand is formed into tiles which are fired in an oven, a coating and an electrode are applied to each side, and there you have it: a compact fuel cell. Elektor's German editor Ernst Krempelsauer is an expert on fuel cell technology, and he sent us the following comments:

#### Note to Bloombox:

In theory, the solid oxide fuel cell (SOFC) can achieve a system efficiency of 55–66%, which is in the range of the most up to date conventional power plants using gas turbines (60%). So when operating with natural gas, there is no progress with regard to the CO<sub>2</sub> balance compared



The proportion of leaky batteries reveals that what we have here is a Pringles battery that has been in service for at least one year. What is more surprising is that quite a bit of energy can still be obtained from the batteries that aren't leaking. Batteries are apparently ideally suited for use in 'second life' applications, such as energy-efficient LED lamps, clocks, small electronic circuits, and (ultimately) the Pringles battery itself.

### Instant electricity – just add water

The Keshe saga continues [2]. During the past 30 years, this man has devoted himself to the realisation of his dream: generating energy from nothing. His name is Mehran Keshe, and he is on the verge of making his dream come true. Elektor has had regular contact with this remarkable person in recent years.

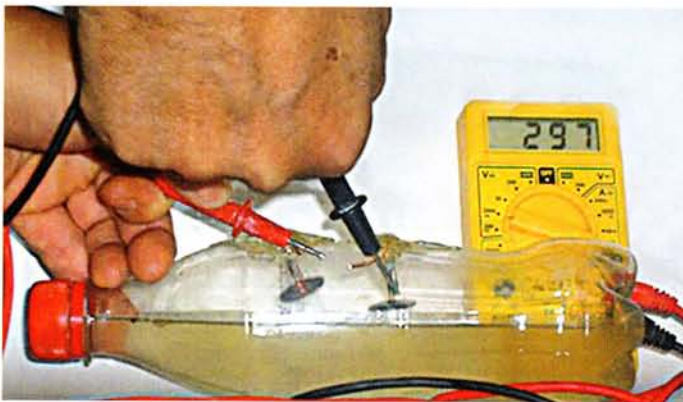

Of course, it's easy to consign these developments to the realm of myth, but at the same time we have an obligation to report on these developments. We like to see things from the latter perspective. His first demonstration, three years ago, took place in a hotel on the Antwerp Ring Road. Inside a cola bottle he reproduced what occurs constantly in the universe, and the result was a small voltage. Over the years since then he has further refined his technology, but the question remains: when is proof really proof? We asked him to prove that he could make a LED light up, and in November 2009 he phoned to report that the LED was shining. He also said that the LED continued to emit light for several weeks, even though we expected it to stop after a few minutes. Naturally, we wanted to see this for ourselves, and a few weeks ago we again invited Mr Keshe to present a demonstration, this time in our lab. Afterward we were not quite sure what to think. We saw what happened and we saw the result, but we were unable to explain it. With his cells connected in simple series and parallel circuits, he managed to generate significant voltages and currents.

What we saw, as always with demonstrations by Mr Keshe, was to a certain extent improvised. His demo model was a compartmented plastic storage tray, such as we use to hold screws and components. There were two metal electrodes in the tray, like those we know from our electrolysis experiments, with the difference that one of these electrodes had been specially treated. He simply added tap water, and – wonder of wonders – this arrangement produced

enough voltage and current to power a computer fan. This continued for a bit less than two hours, after which the fan stopped turning. A deposit had formed around the wires in the plastic tray, and he said that this prevented the further generation of electricity. According to Keshe, this deposit consisted of CO<sub>2</sub>, and this was confirmed by reports he sent later.

Instant electricity – just add water! This seems to be the gist of the story. We were already imagining a pocket torch that you could fill with water instead of inserting batteries, so you would have a torch that could in principle produce light indefinitely. A few weeks later we received an e-mail message with a photo: the flashlight actually worked!

### Tech the future

What role does technology play in solving major issues related to energy and sustainability? The answer is that technology plays a double role: as a cause and as a solution. Everyone who has a basic understanding of Ohm's law knows that using electricity to move yourself around is the worst of all possible options and that our electricity distribution network is simply not able to meet the increasing demand for electrical energy – but what can meet this demand? How can technology help us resolve these issues?

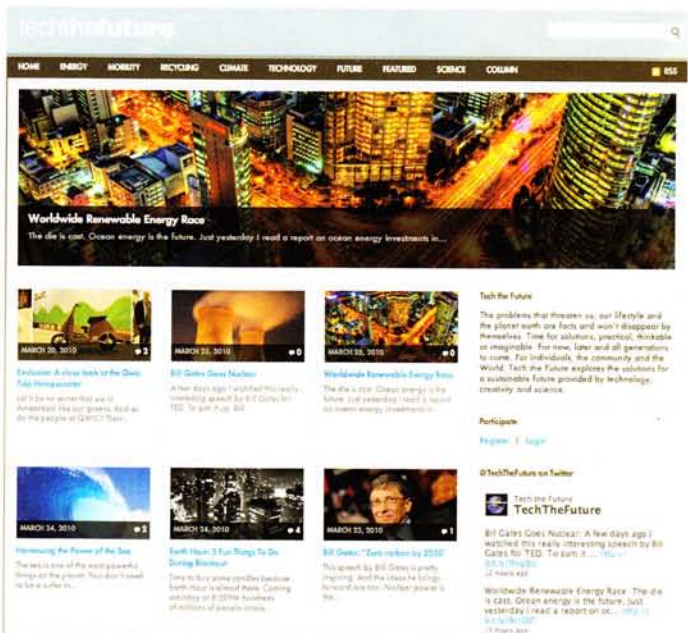

In any case, information plays a key role here. Providing information on the latest developments, mentioning solutions, asking questions and thinking laterally: all of this is necessary, and this is a typical job for Elektor. To give this process a boost, we are also collaborating with the Techthefuture.com website.

(100122-1)

### Internet Links

- [1] [www.bloomenergy.com](http://www.bloomenergy.com)
- [2] <http://keshetechnologies.com>

# OBD2 Mini Simulator

## Virtual car supports PWM/ISO/KWP2000

By Folker Stange and Erwin Reuss (Germany)

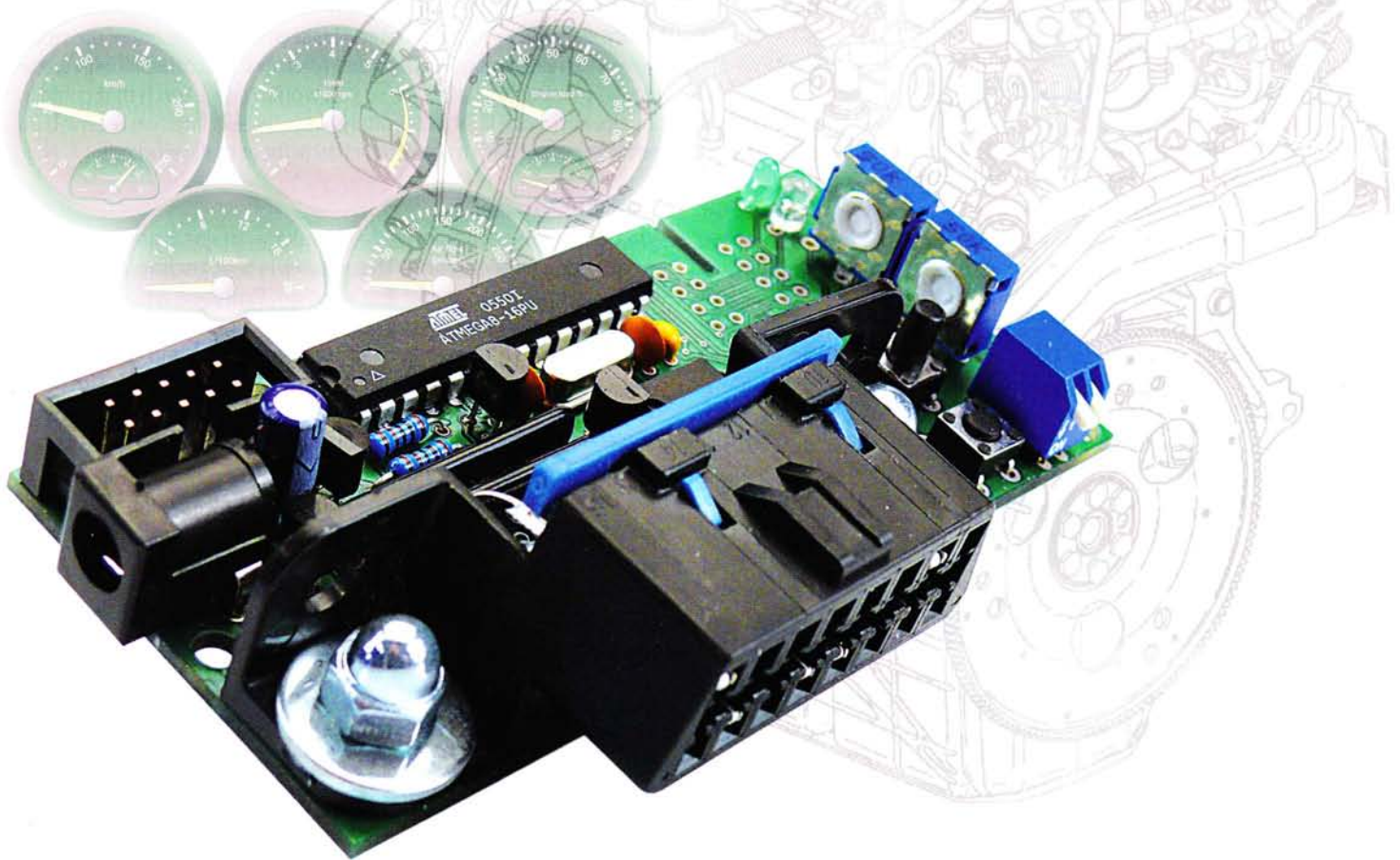

Designers working with the OBD vehicle diagnostic port have a problem when it comes to equipment testing. A full sized car parked next to your bench may technically be a good solution but in most cases just isn't not possible. You don't need to resort to expensive professional equipment to do the job. The MiniSim OBD simulator device described here is a low-cost and efficient unit which simulates communication from a vehicle's OBD port and can communicate using four of the most popular OBD protocols. This is a very useful tool for anyone thinking about developing OBD hardware or software or even just for test purposes.

The MiniSim simulates the signals that you would normally expect to encounter when you plug an OBD analyser into your vehicle's

OBD2 connector. This allows you to carry out testing and development of a new analyser design from the comfort of your own

lab bench. Testing on a real vehicle can be a little uncomfortable especially if you don't have the option of working in a garage. Even

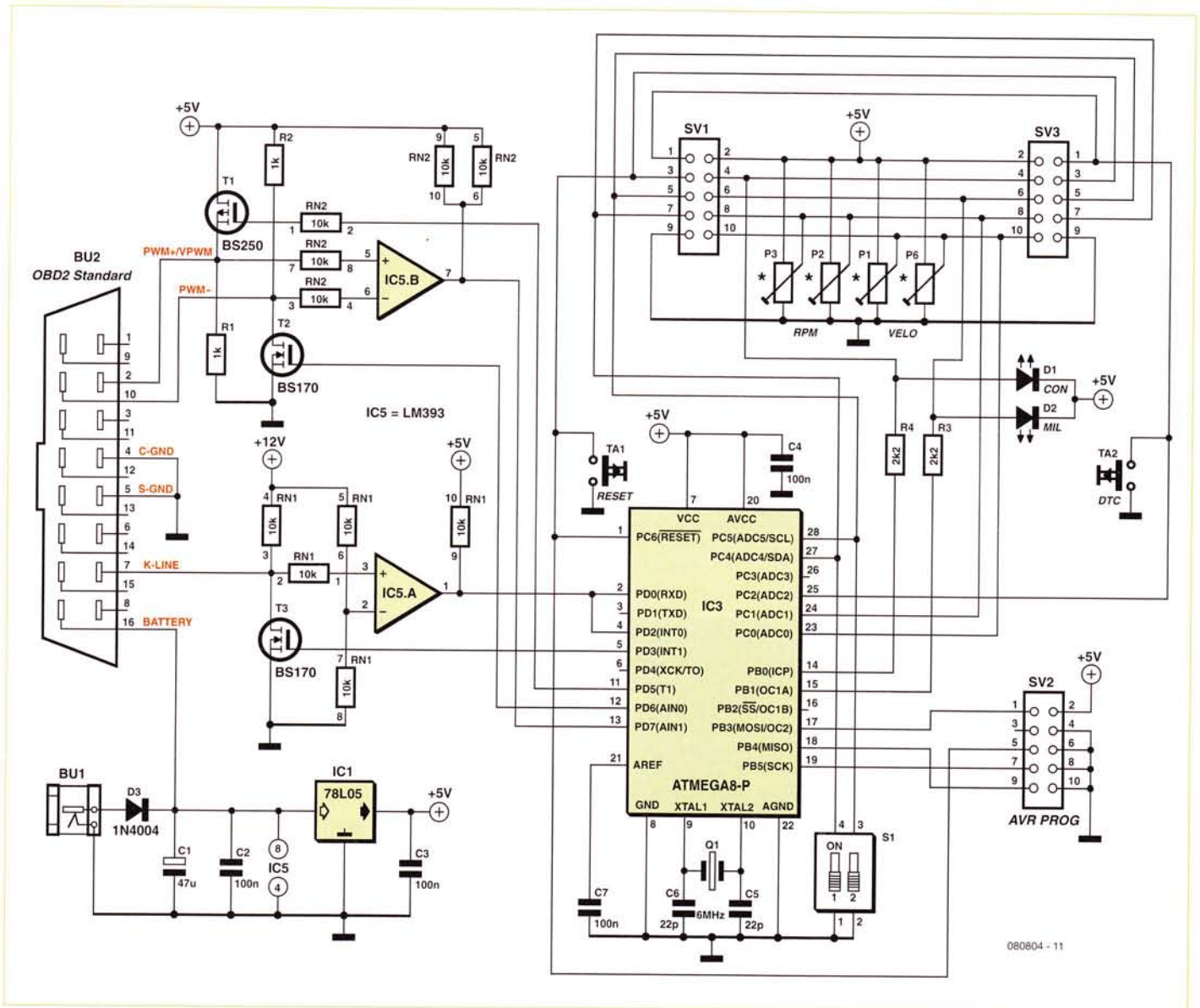

080804 - 11

Figure 1. The circuit consists of a microcontroller with firmware, MOSFETs and comparators to perform the necessary voltage level-shifting (5 V/12 V). The pots allow control of the simulated vehicle speed and engine rpm.

then you will most likely need to test an OBD analyser on several different makes of cars to ensure compatibility with every protocol.

The need for a convenient, bench top OBD2 simulator gave rise to the design of this unit. It can send out pre-programmed sensor values and indicate a MIL condition. It also supplies freeze frame data and a selectable number of trouble (error) codes. This simulator supplies a Vehicle Identification Number (VIN) as 'AGV-MINI-SIM V1.0' in the appropriate format.

The simulator has been designed to make a useful and versatile tool whilst keeping the design simple and using minimum hard-

ware. The OBD2 simulator supports four of the most popular OBD protocols. The CAN-bus protocol however would require a much greater hardware investment and has not been implemented.

### Circuit and function

The microcontroller used in the simulator circuit (Figure 1) is the popular Atmel Mega8 clocked at 6 MHz, a standard 10-pin header can be fitted to the board to allow

## Specifications

- Four predefined protocols:
  - KWP2000 Fast Init
  - KWP2000 Slow Init (5-Baud Init)
  - ISO9141-2
  - PWM J-1850
- Protocol selection using DIL switches
- Four predefined error codes
- Up to 15 configurable error codes
- Sensor data for speed and rev count adjustable by potentiometer
- MIL generation by pushbutton
- 'Connect' and active 'MIL' indicators
- Freeze frames store sensor data when MIL is generated
- Several assembly options

**Table 1.**  
Protocol selection using S1

Protokoll	S1-1	S1-2
KWP2000 Fast Init	Off	Off
KWP2000 5-Baud Init	On	Off
ISO9141-2	Off	On
PWM J-1850	On	On

in-circuit device programming. The peripheral hardware takes care of the communication interface signal levels and is controlled by the microcontroller appropriate to the protocol selected. The 10-pin SIL resistor network contains five independent resistors so it does not matter which way round it is fitted. A 78L05 voltage regulator is sufficient to handle the circuit's power requirements. The use of MOSFETs as signal drivers simplifies the circuit and gives clean, fast edges to the transmitted data.

Received data from the OBD connector is routed to comparators (IC5.A and IC5.B) and converted to TTL levels to ensure compatibility with the controller I/O. LED D1 ('connect') indicates successful connection to an OBD analyser (or scanning tool). LED D2 is the MIL (Malfunction Indicator Lamp) which indicates that a fault has been detected. With a press of pushbutton TA2 'DTC' the settings of the 'VELO' and 'RPM' potentiometers are stored in a freeze-frame data file in just the same way that a snapshot of sensor readings would be stored in an engine's ECU whenever a fault is detected. Each trouble code therefore has its own 'environment'

of sensor readings which would normally be used by a technician to give additional information about the conditions which existed when the fault occurred. VELO or velocity is the vehicle speed in km/h or mph.

The type of protocol used is selected via the two-pole DIP-Switch S1 (see **Table 1**). After power-up the controller reads the position of switch S1. To change protocols after power-up, select the required protocol on S1 and then perform a reset. The reasoning behind this is that a real vehicle does not normally have the option to change its OBD2 protocol. From the analyser's point of view a change of protocol will always be preceded by loss of power as the scan tool is unplugged from one vehicle and plugged in to another. The simulator requires a supply from a mains adapter in the range of 12 to 15 V. This voltage is linked to pin 16 of the OBD2 connector. A diagnostic scan tool connected here will usually draw its supply from this pin. Be aware that the protection diode D3 introduces a 0.6 V voltage drop between the mains adapter supply and the voltage at pin 16. This can be reduced by substituting a Schottky diode for D3.

**Construction**

With no SMD devices in sight the board (**Figure 2**) is relatively easy to populate. Start with the smallest components: resistors, protection diodes and then both ICs. Sockets can be used for the ICs but are not strictly necessary. Next fit the decoupling capacitors and the loading capacitors around the crystal and then the crystal itself followed by the resistor network. Next is the transistors, voltage regulator and if required, the programming connector pin header. The PCB layout can accommodate either vertical standing or horizontal lying pots. The upright positions are identified as P1 and P2 whilst the horizontal positions are identified as P5 and P6. The DIP switch S1 is available in two variants: switchable from the side or from above.

The OBD connector can be fitted horizontally or vertically but first it must be manually assembled. Fit contacts in positions 2, 4, 5, 7, 10 and 16 then secure them with the blue plastic packing strips pushed up

**COMPONENT LIST**

**Resistors**

- R1,R2 = 1kΩ
- R3 = 2.2kΩ
- R4 = 1.5kΩ
- RN1, RN2 = 5-way SIL 10kΩ resistor array, 10-pin (SIL 10-5, see text)
- P1,P2 = 100kΩ trimpot with spindle, vertical mounting
- or
- P5,P6 = 100kΩ trimpot with spindle, horizontal mounting (see text)

**Capacitors**

- C5,C6 = 22pF
- C2..C4,C7 = 100nF
- C1 = 47μF 25V

**Semiconductors**

- T1 = BS250
- T2,T3 = BS170
- IC1 = 78L05

- IC3 = ATmega8-16PU, programmed \*)
- IC5 = LM393
- D1,D2 = LED, 3mm
- D3 = 1N4004

**Miscellaneous**

- Q1 = 6MHz quartz crystal
- BU1 = low voltage DC adapter socket, PCB mount
- TA1,TA2 = miniature pushbutton, 1 pole, PCB mount
- BU2 = OBD socket
- PCB \* # 080804-1 (contained in kit)
- Kit of parts with PCB and all components, order code 080804-71 (see Elektor Shop section, or [www.elektor.com/080804](http://www.elektor.com/080804)).

\* Project software and PCB design: free download from [www.elektor.com/080804](http://www.elektor.com/080804)

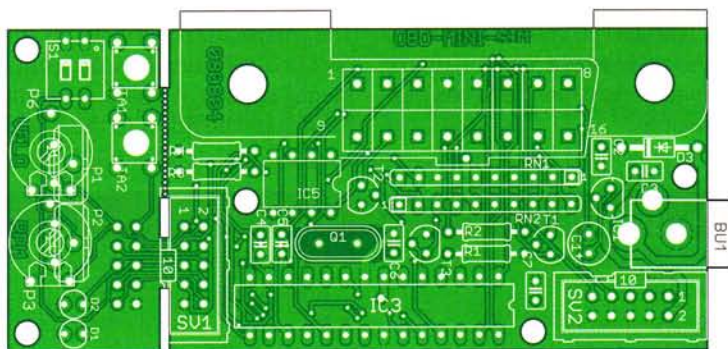

Figure 2. The PCB does not use any SMD devices. The smaller user-interface section can be separated from the main part of the PCB and linked via a ribbon cable.

## Why so many protocols?

The OBD2 interface has undergone continued refinement and development since its introduction in The United States in 1996. The first protocol used VPWM with a communication transfer rate of 10,400 Baud and 8 V signal levels. In 1997 Ford introduced a PWM protocol in petrol-engine vehicles. This uses a faster communication rate of 41,600 baud and requires a relatively higher performance hardware interface. Because of the faster data rate some manufacturers of OBD diagnostic equipment have tended to overlook support for it in their diagnostic tools. Communication set up with this standard is also a bit tricky and data transfer prone to interference. It was not long before manufacturers started to replace it by the CAN bus protocol (particularly Ford). In 2000 the ISO9141-2 protocol was introduced Europe wide. It is closely related to the KWP2000 Slow Protocol (Key-Word-Protocol). It has a data format very similar to RS-232 standard with a data rate of 10,400 Baud and a signal level corresponding to the vehicle battery voltage of 12 V. Even today vehicles such as the Toyota Aygo, Citroen C1 and Peugeot 107 which share a common mechanical platform use this ISO9141-2 Protocol. The more recent CAN bus is a versatile protocol designed to provide fast, secure communications and command pathways between subsystems throughout a vehicle. Its versatility means that an interface is more sophisticated and therefore more expensive than most of the other protocols.

from the solder-end of the connector. These help prevent the contacts from being forced back as the connector is used. More details together with some illustrations of the connector assembly can be found on the project site [1]. Once the connector is assembled mount it to the PCB with screws before carefully soldering the connections to the PCB pads. **Figure 3** shows a sample PCB fitted with a horizontally mounted OBD connector, side-action DIP switch and pre-sets fitted with actuating spindles.

To increase the versatility of the device the PCB is designed so that it can be separated into two (with the help of a fine-toothed saw). The two PCB parts can now be linked using a length of 10-way flatcable (10 to 20 cm long) between positions SV1 and SV3. This gives you the option to mount the OBD port connector away from the user-interface section of the PCB. **Figure 4** shows one example of how this can be done. It can also be easily fitted into an enclosure or integrated into some form of presentation panel.

### Power to the circuit!

Once you are sure all the components have been fitted correctly the simulator board can be powered-up. Use a standard 12 V mains adapter, connect the OBD analyser unit and check that the supply rails voltage lies in the region of 12 to 14 V.

The microcontroller is supplied pre-programmed so that one of four protocols can be selected by the switch setting of S1 (see **Table 1**). With both switches of S1 in the 'off' position the KWP2000 fast protocol will be selected. At power-up both LEDs light briefly. An OBD2 analyser device can now be connected to the unit. For OBD analysers with a PC connection (such as the Analyser-NG with Bluetooth) now is the time to start any diagnostic software on the PC. MoDiag [2] is a good example of this type of program. With everything functioning correctly so far use the Connect via KWP2000 command and receive data. Select the page showing sensor data and observe the received values. The two potentiometers allow control of vehicle velocity (VELO) and engine speed (RPM). The moDiag program

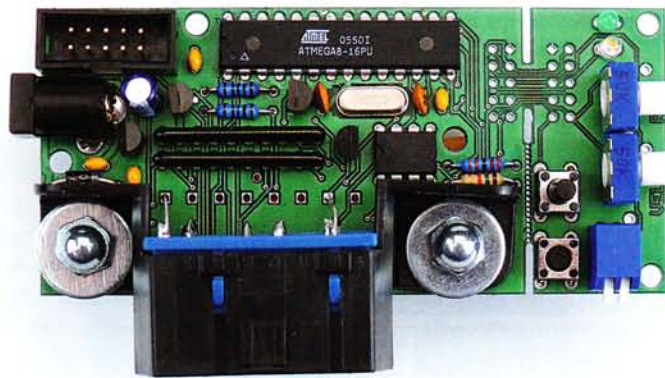

Figure 3. A completed sample PCB with a horizontally mounted OBD connector and side-activated DIP switches.

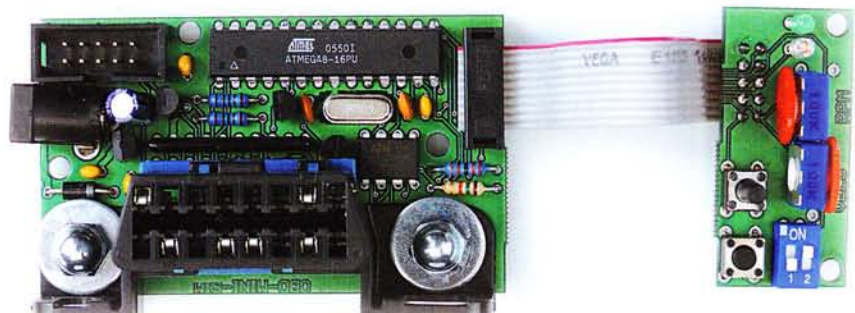

Figure 4. Sample board showing a vertically mounted OBD connector and separated user-interface section.

## Overview of the programmed PIDs

### Mode 1:

- 0100 PIDs supported 01..20
- 0101 DTC Count, MIL lamp, monitor support/status
- 0103 Fuel system status
- 0104 Calculated Load Value
- 0105 Engine Coolant Temp.
- 010A Fuel Pressure
- 010B Intake MAP
- 010C Engine Speed (RPM) (POTI)
- 010D Vehicle Speed (VELO) (POTI)
- 010F Intake Air Temp.
- 0110 Mass air flow (MAF)
- 0111 Absolute Throttle position sensor
- 0113 Location of Oxygen Sensors
- 0114 Bank #1 - O2 sensor #1
- 011C OBD requirements level

### Mode 2 – Freeze Frames:

- 0200xx PIDs supported 01..20
- 0202xx DTC that caused freeze frame
- 0204xx Calculated Load Value
- 0205xx Engine Coolant Temp.

- 020Cxx Engine Speed (RPM) (aktueller POTI-Wert)
- 020Dxx Vehicle Speed (VELO) (aktueller POTI-Wert)

xx = Frame-Nummer (wird jedoch ignoriert, alle Frames identisch)

Die Freeze Frames werden nur für den ersten Fehlercode gespeichert.

### Mode 3 - DTC:

- 03 Read Errorcodes

### Mode 4 - Clear DTC:

- 04 Clear Errorcodes

### Mode 9 - VIN:

- 0900 PIDs supported 01..20
- 0901 Frame count for PID 02
- 0902 VIN "AGV-MINI-SIM V1.0"

can use this data to produce a simulated acceleration measurement. One feature of the MiniSim is that it can only initiate a MIL after a Connect. Once Connect

is successful the MIL button can be pressed which lights the LED and stores the current values of VELO and RPM into the freeze-frame store where they can be later read.

The stored trouble codes can also be erased providing the analyser device is capable of this action. The MIL LED will then turn off. Requesting VID in Mode 9 will cause the MiniSim to send the VIN which in this case will always be: AGV-MINI-SIM V1.0.

### Software and configuration

The Firmware is written in Assembler and the resultant Hexcode file is available for free download [1]. Included in the download is the configuration file MiniSimConfig.

The pre-programmed MiniSim controller can implement four protocols (see table) and four trouble codes. In addition it is possible to configure an additional 11 trouble codes by means of the OBD2 interface [3]. To make use of them it is necessary for the analyser device to be using either the AGV or DXM chipset, the configuration commands are integrated into the chips. A very simple tool to use here is the Analyser-NG [4] with Bluetooth interface [5]. Now start the configuration program MiniSimConfig. The Analyser-NG must first be connected via Bluetooth to the notebook and also plugged in to the OBD port of the MiniSim.

The Bluetooth COM port can be setup in the Config program, even though it has most probably already been configured during correct installation of the device. After successfully connecting a total of 15 trouble codes can now individually be selected, set up and activated. The EXIT button stores the current configuration into the controller's non-volatile EEPROM. Lastly, note that the positions of S1 are only read at switch-on, any change of S1 will not be recognised until the unit undergoes a reset.

(080804)

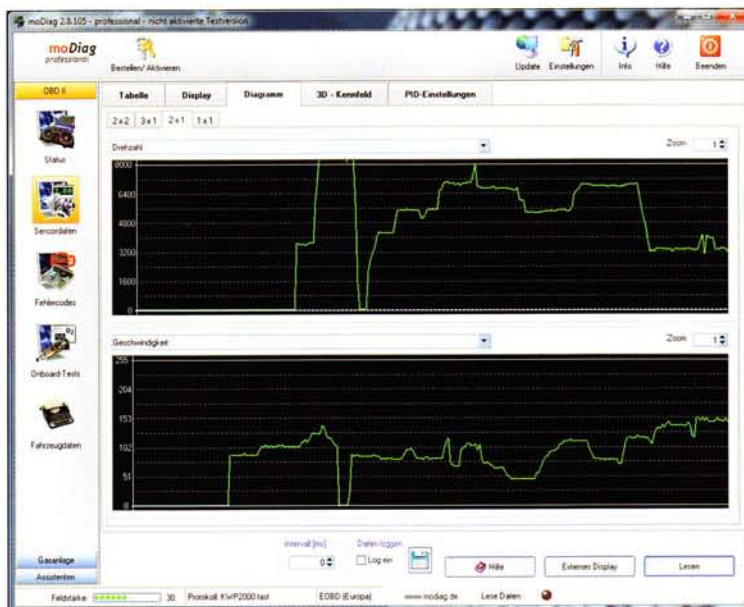

Figure 5. The moDiag program running on a PC is useful to display the simulated values.

[1] [www.elektor.com/080804](http://www.elektor.com/080804)

[2] [www.modiag.de](http://www.modiag.de)

[3] [www.obd-diag.com](http://www.obd-diag.com)

[4] [www.elektor.com/090451](http://www.elektor.com/090451)

[5] [www.elektor.com/090918](http://www.elektor.com/090918)

NURVE NETWORKS LLC

# XGAMESTATION

Powered By  
Atmel MEGA AVR 644  
64K FLASH  
4K SRAM

## AVR 8-BIT

XGS AVR 8-Bit Main PCB Board.  
XGS Gamepad Controller.  
325+ Page Printed Manual.  
Atmel AVR ISP MKII Programmer.  
9V Power Supply & A/V Cable.  
PC Serial Port to XGS Converter.  
PC DVD-ROM.  
1GB Micro SD Card + Adapter.  
Bonus: eBooks on Hardware,  
Game Console Design, and More!

Visit Youtube  
Channel:

XGSDEV

THE MOST COMPLETE ATMEL MEGA AVR DEV. KIT AVAILABLE!  
[WWW.XGAMESTATION.COM](http://WWW.XGAMESTATION.COM)

# www. elektor. com

Schaeffer  
AG

## FRONT PANELS & HOUSINGS

Cost-effective single units and small production runs

Customized front panels can be designed effortlessly with the Front Panel Designer. The Front Panel Designer is available free on the Internet or on CD.

### New Version 4.0

with new features, for example  
free contours for Linux, Windows  
and Mac OS X

- automatic price calculation
- delivery in 5-8 days
- 24-Hour-Service if required



Sample price: 34,93 €  
plus VAT/shipping

Schaeffer AG · Nahmitzer Damm 32 · D-12277 Berlin · Tel +49 (0)30 805 8695-0  
Fax +49 (0)30 805 8695-33 · Web info@schaefter-ag.de · www.schaefter-ag.de

# 30 Watt Solar Panel Kit

Get off the grid with a do-it-yourself system that can produce up to a maximum of 30 watts of clean, green electrical energy! Once assembled you will have a solar panel that produces a substantial amount (6 volts) of electrical power. The energy produced per square foot is comparable to commercially available solar panels. Daisy-chain multiple units together for higher voltage/current/power output! Dimensions: 23.8 x 15.8 x 0.375 in (60.45 x 40.12 x 0.95 cm). Online videos show you how to properly handle and solder the delicate cells and their wiring interconnections.

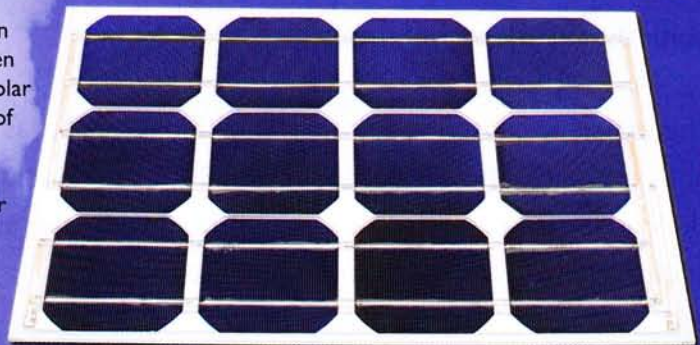

30 Watt Solar  
Panel Kit  
#33000



# PARALLAX

[www.parallax.com](http://www.parallax.com)

"ParallaxInc" on Twitter, Facebook, and YouTube



Milford Instruments  
[www.milinst.com](http://www.milinst.com)

Spinvent  
[www.spinvent.co.uk](http://www.spinvent.co.uk)

# Wireless Electricity meets RFID

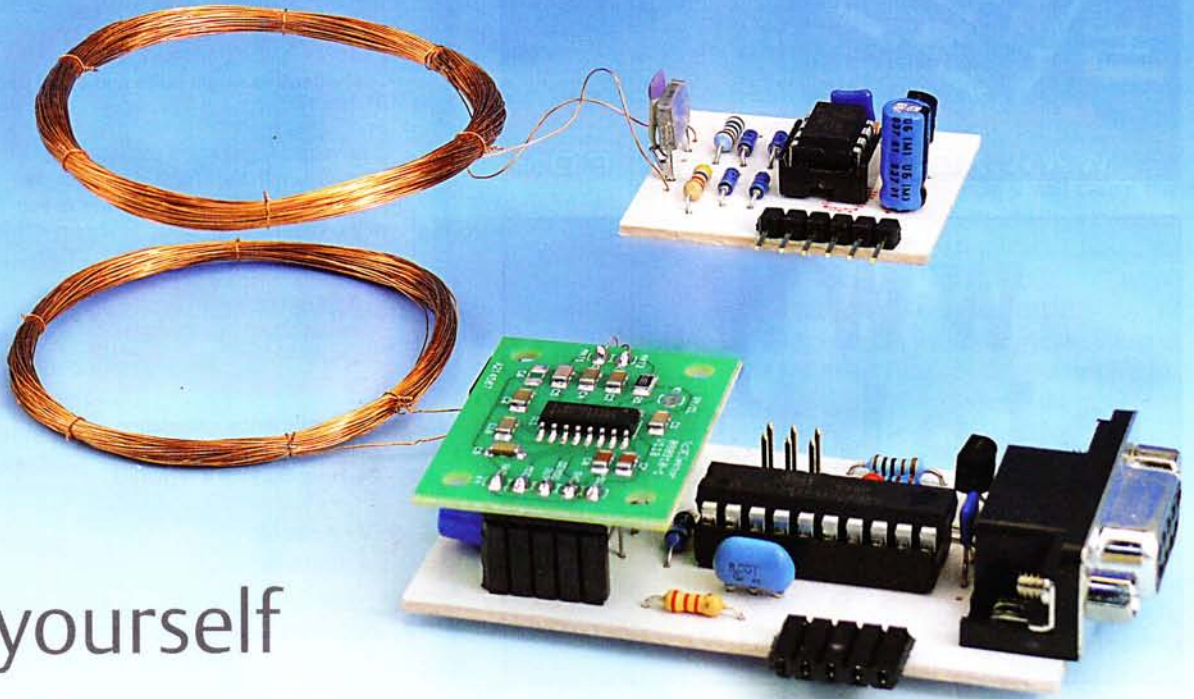

## Do-it-yourself wireless RFID sensor systems

By Martin Ossmann (Germany)

In this article we describe a do-it-yourself RFID reader as well as a way of making your own RFID tags. What's more, we show how to make RFID tags that include a transducer, opening up the possibility of making RFID sensors. The tiny sensor module operates without an internal power source and delivers its readings to the RFID reader for further processing.

RFID tags based on the EM4102 chip are cheap, even in small quantities, and readily available. In a recent issue of *Elektor* we published a design for a reader for these tags [1]. In this project we use a small printed circuit board with the EM4095 reader IC mounted on it, which allows us to transfer the data from the RFID tag to an ATM18 test board. The reader board is available with the SMD components already mounted.

It can also be used to make an RFID reader using an ATtiny2313. Suitable freely-usable routines for reading the data from the

EM4102 are included in the software download that accompanies this article. The more interesting part of this project, however, is where we show you how to build your own RFID tags, adapted to whatever application you have in mind. We then go on to look at how to build sensors into these tags, and communicate sensor data to the reader device. These sensors are electrically isolated and can move freely in space.

### Energy transfer

The EM41022 RFID tag IC receives energy from the reader by inductive coupling at a

frequency of 125 kHz. The author's thought was that if this device can do it, there is no reason why we should not make our own RFID tags. Furthermore, the data rate offered by the EM4102 is not very high, and in particular should be well within the capabilities of a simple microcontroller.

The circuit shown in **Figure 1** was used to determine how much energy is available from the receiver coil. The RFID reader was fitted with the recommended coil ( $L=750 \mu\text{H}$ , 85 turns of 0.25 mm diameter / AWG #30 enamelled copper wire, coil



## Features

### RFID reader:

- standard microcontroller (ATtiny2313)
- works with EM4102-compatible RFID tags
- output over RS232 interface

### DIY and sensor RFID tags:

- standard microcontroller (ATtiny13)
- EM4102 compatible
- analogue and digital inputs for sensors
- status and readings transmitted via RFID ID
- separate adaptor board for programming and debugging

### Open source software collection:

- RFID reader firmware
- DIY RFID tag firmware for:
  - standard RFID tag (fixed ID)
  - RFID tag with alternating ID
  - RFID tag with switchable ID
  - RFID tag with configurable ID
  - RFID tag with two analogue inputs
  - RFID tag with temperature sensor

### Availability:

Kit available from *Elektor Shop* including reader module, printed circuit boards and ready-programmed microcontroller: see parts lists.

diameter 50 mm). For the receiver coil (L1) we used a 95-turn coil with an inductance of 1 mH, tuned for resonance at 125 kHz with C1. Transmit and receive coils were mounted one above the other, parallel to one another and 20 mm apart. Current and voltage were measured as the resistance R was adjusted. The left-hand graph in **Figure 2** shows the measured voltage as a function of current, while the graph on the right shows the transmitted power. Curves are shown for the cases where the tuning capacitor value is 200 pF too great and 200 pF too small, to illustrate the effect of below-optimal tuning. From the graphs it appears that at a voltage of 3 V it is possible to transfer a couple of tens of milliwatts of power. An ATtiny microcontroller draws about 2 mA at an operating voltage of 3 V and a clock frequency of 1 MHz; at 125 kHz the current drawn is less than 0.1 mA. So it seems that there will be no difficulty finding enough power to operate the microcontroller.

The EM4102 RFID IC communicates its ID by modulating the load on the reader. Each bit transferred takes 64 cycles of the 125 kHz carrier, giving a gross data rate of 1953.125 bits per second. A complete packet can be transferred in 32.768 ms. It is possible to use the 125 kHz signal as a clock for the RFID controller. This automatically ensures that the bit clock is synchronous with that in the reader, and current consumption at this clock rate is, as we saw above, very low. However, it also means that the CPU will have only 64 clock cycles to calculate the next bit to be transmitted: for this reason we program the CPU (the ATtiny13) in assembler.

### RFID? DIY

**Figure 3** shows the complete circuit diagram of our DIY RFID tag. The microcontroller is provided with a clock from the resonant circuit formed by L1 and C1. Simultaneously, the diode bridge rectifies the 125 kHz AC signal and supplies the CPU with power. T1 allows the resonant circuit to be loaded, and it is through modulating this load that the microcontroller can transmit data. However, the signal level must not be reduced excessively, or else the clock to the CPU will be lost.

We have developed a printed circuit board for the circuit in the *Elektor labs* (**Figure 4**). The coil is wired in parallel with C1, and so connection points are provided adjacent to it. A suitable reader is available in the form

of the SMD board mentioned above [1] using the EM4095, although that project did not use the BASCOM library used in the ATM18 system to drive the IC. As in one of the author's previous projects [2], special

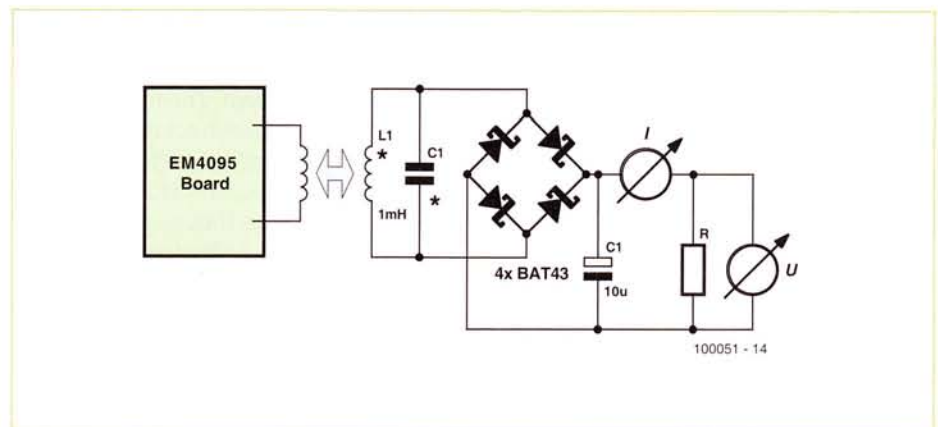

Figure 1. Circuit to measure the power transferred to receiver coil by the RFID reader.

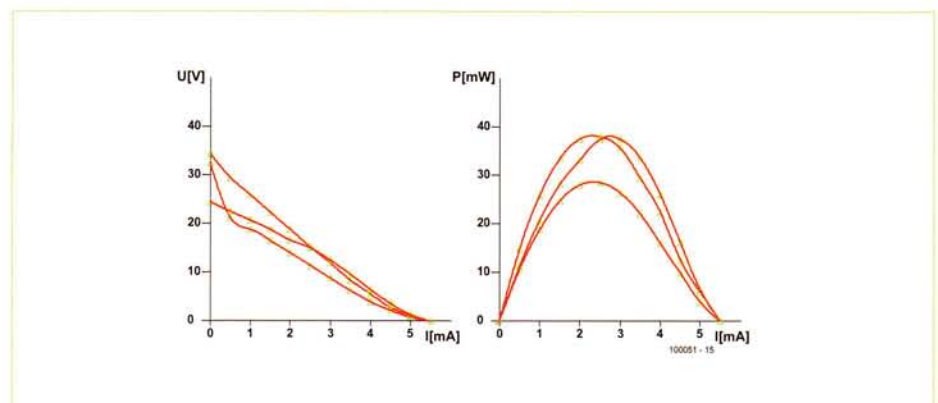

Figure 2. Results of the energy transfer tests: voltages, currents and power.

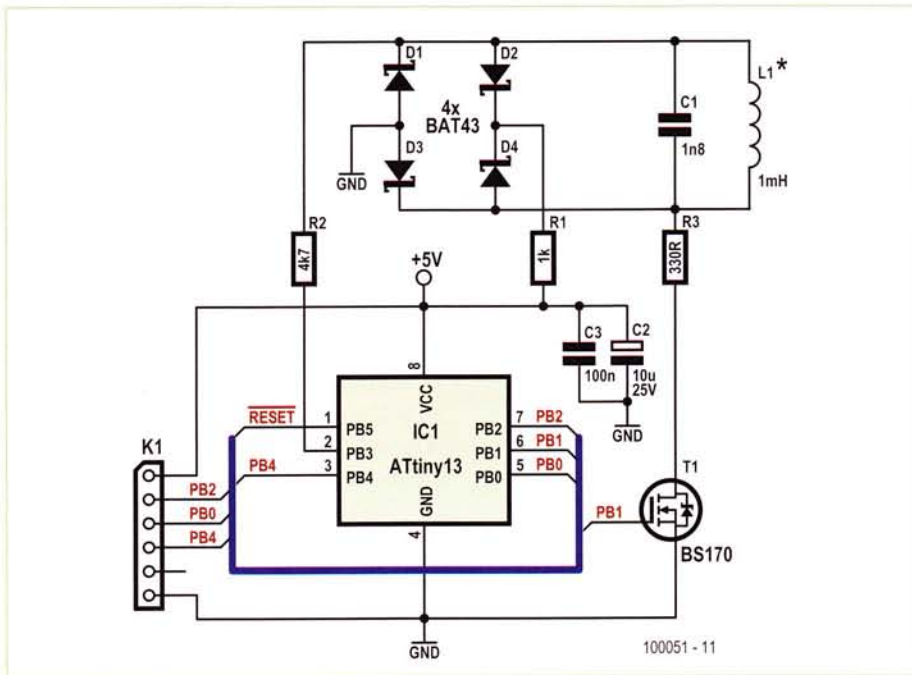

Figure 3. Circuit of the DIY RFID tag using an ATtiny13.

software was written for the reader in C (using WinAVR/GCC).

The circuit of the reader in **Figure 5** is very simple and can easily be built using perforated prototyping board. But to make things even easier, *Elektor* labs have designed a printed circuit board (**Figure 6**). The EM4095 board is connected at K3 (**Figure 7**). The coil connected to ANT1 and ANT2 on this board should have an inductance of 750 μH. This is not critical, however, as the EM4095 regulates the frequency using an internal PLL: otherwise the frequency would not match optimally with the RFID transponder, whose frequency is fixed at 125 kHz.

The data bits from the RFID tag are demodulated by the EM4095 [3] and passed on to the microcontroller in the form of a Manchester-coded stream. The first job of the microcontroller is to extract the bits. This is done in an interrupt service routine which is triggered 8 MHz/256 = 31250 times per second. A data bit is thus exactly 16 interrupt periods long (see **Figure 8**).

The code snippet shown in **Listing 1** decodes the Manchester-coded stream. The code measures for how long the logic level on port pin D.4 remains steady: the variable Duration is incremented as long as inBit is equal to OldBit. When the level changes,

Listing 1. Manchester decoding

```

if ( PIND & 4 ) { inBit=1
; }
if ( inBit==OldBit ) {
Duration +=1 ;
}
else {
if (Duration>=12) {
PutInFifo(OldBit) ;
}
if (Duration>=4) {
PutInFifo(OldBit) ;
}
Duration=1 ;
OldBit=inBit ;
}
    
```

one or two new half-bits have been received with value equal to OldBit. Depending on the measured duration, either one or two half-bits are stored in a FIFO queue for later processing using PutInFifo(OldBit).

The decoding routine itself takes half-bits from the FIFO queue. The first task is to recognise the start of a data packet: to do this the software moves the half-bits along a shift register until the synchronisation sequence is found. Subsequent data bits are then decoded and output over the RS232 port (19200 baud, 8N1 format). While these are being output new half-bits may arrive and wait in the FIFO queue until the main program is able to process them: this ensures no bits are lost. The RFID reader can be used to read any standard RFID tags compatible with the EM4102 [4].

## COMPONENT LIST: DIY RFID

### Resistors

- R1 = 1kΩ
- R2 = 4.7kΩ
- R3 = 330Ω

### Capacitors

- C1 = 1.7nF (see text)
- C2 = 10μF 25V
- C3 = 100μF 25V

### Inductor

- L1 = 1mH (see text)

### Semiconductors

- D1–D4 = BAT43
- IC1 = ATtiny13-20PU, programmed, Elektor # 100051-41\*

### Miscellaneous

- K1 = 6-way right-angled pinheader PCB # 100051-1\*

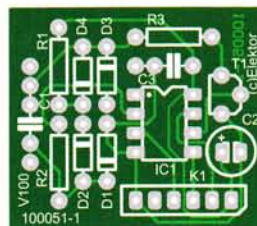

Figure 4. Printed circuit board for building the RFID tag.

## Coils

For both the RFID readers and for the tags it is simplest to wind the coils yourself as suitable ready-made coils are practically unobtainable at least in very small quantities. The job can be done without an inductance meter. Application note AN411 by EM Microelectronic, called 'RFID made easy' [5], gives a helpful formula for calculating the inductance of an air-cored coil of this type:

$$L = \frac{\mu_0 DN^{1.9}}{2} \ln\left(\frac{D}{d}\right)$$



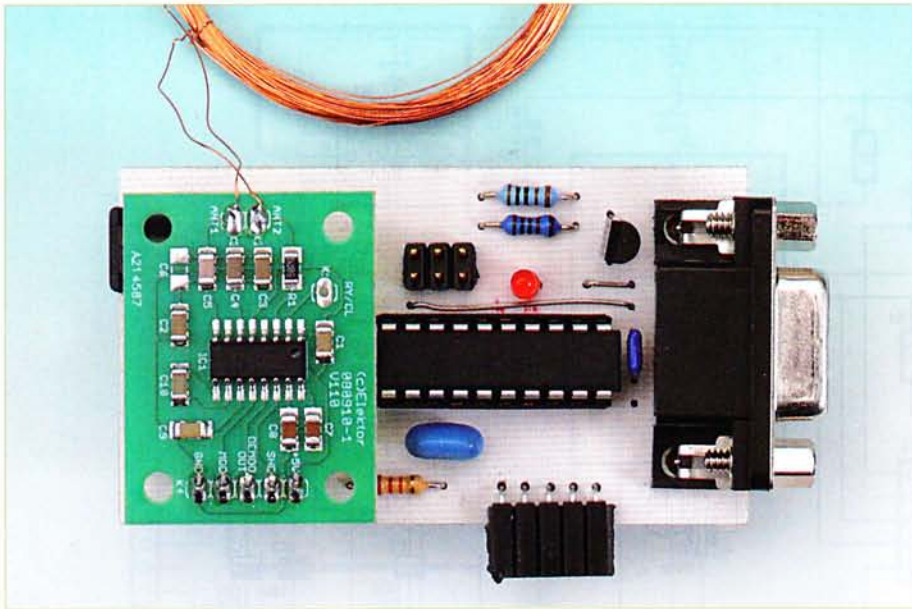

Figure 7. Lab prototype of the reader. The receiver coil is connected to the EM4095 board.

changing a bit in the PWM generator registers. This all happens in an interrupt service routine (Listing 2).

Register IntBit contains the data bit that is to be transmitted, and IntMail is set to 1 to acknowledge that the bit has been accepted. The main program is then only responsible for marshalling the data bits along with their accompanying check bits. To ensure that the system works as reliably as possible with an unstable supply voltage,

the brown out detection threshold is set to 1.8 V and the watchdog is enabled.

**Data packet and payload**

A complete data packet is formed as shown in Table 2. The packet commences with nine ones. This preamble cannot occur elsewhere in the packet and can therefore be used to recognise its start. The data bits proper, or 'payload', starts after the preamble. The payload consists of ten groups of four bits, or nibbles.

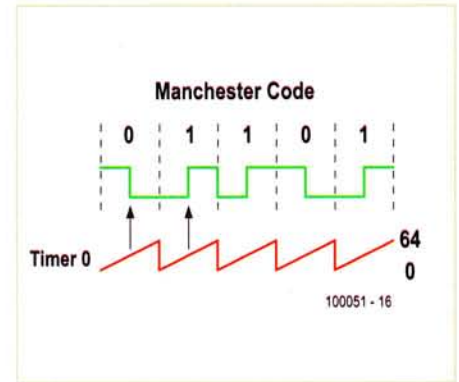

Figure 8. Manchester coding.

The first two nibbles form the customer ID. Eight data nibbles follow. After each nibble a 'row' parity bit for that nibble is sent. After ten such nibbles a row of 'column' parity bits is sent, followed by a zero. So in total a packet consists of  $9+10 \cdot (4+1)+4+1 = 64$  bits. Each bit lasts for 64 of the 125 kHz clock cycles, and so the bit rate is 1935.125 bits per second and a complete packet takes 32.768 ms to transmit.

To use this protocol for an RFID sensor we have eight data nibbles and two ID nibbles at our disposal, making a total of ten hexadecimal digits or 40 bits. This is enough to transmit a good deal of information, although if you wish to extend the protocol this project gives you everything you need.

**RFID tag construction and extensions**

Figure 9 shows a prototype of the DIY RFID tag using the printed circuit board in Figure 4 (which corresponds to the circuit diagram of Figure 3). To make it easier to adjust the resonant circuit the capacitor and coil can be attached via a plug and socket. It is then possible to experiment with various coils: experience shows that in practice the best range is achieved when using a capacitor value about ten percent higher in value than theoretical calculations would indicate.

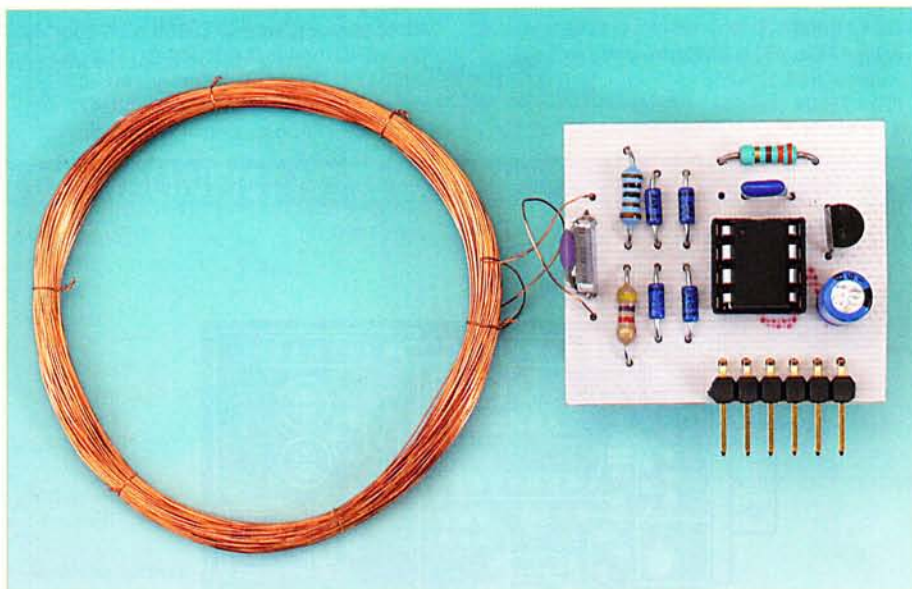

Figure 9. Populated DIY RFID tag board. Sensors can be connected to the header.

Since the RFID software has been written specially for this project and is available as

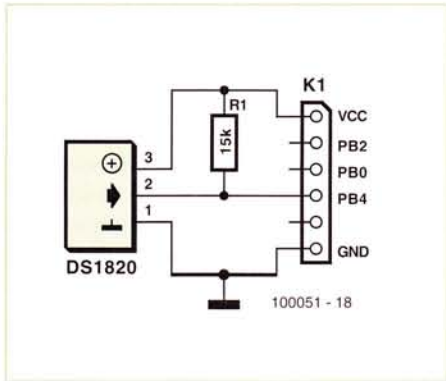

Figure 11. Connecting a DS1820 temperature sensor to K1 on the DIY RFID tag board.

a source code download at [6], it is of course possible to modify the programs to equip your DIY RFID tags with novel functions. Header K1 on the printed circuit board can be used to connect switches, potentiometers and other sensors, which can then be interrogated wirelessly by the reader. This opens up the possibility of taking sensor readings from rotating or otherwise moving parts, as well as providing galvanic isolation in high-voltage environments. Sensors can be suspended in fluids, with their readings safely brought back to dry land.

Range tests indicate that when using a coil with a diameter of 50 mm a gap between reader and tag of 60 mm can easily be bridged. Below we give a few examples of the kind of novel applications that can be realised using RFID sensor tags. These examples are supported by code in the software collection (downloadable at [6]), where the README text gives an overview of the individual programs and corresponding required settings.

### Dynamic ID and status requests

For our first example we consider an RFID tag programmed so as to switch between two ID codes. This idea can be used as a starting point to make RFID keys that can open more than one lock.

The first version uses a switch to select between the two codes. This gives two possibilities: remotely determining the position of a switch, or making a tag whose ID can be

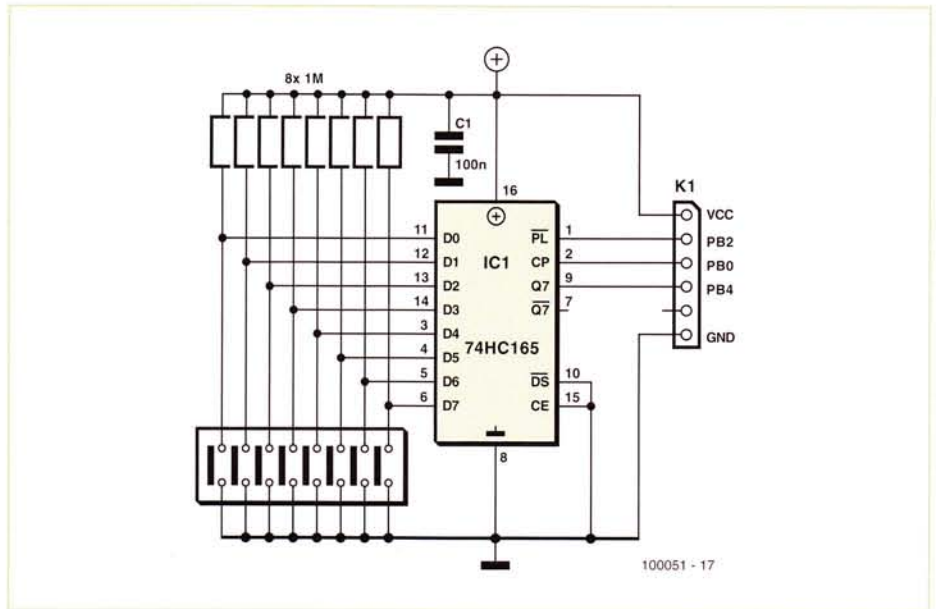

Figure 10. This expansion circuit allows the connection of up to eight switches to the RFID tag.

changed at the press of a button. The corresponding program is included in the download accompanying this article. The switch is connected between port pin B.4 (pin 3 of the ATtiny13) and ground.

Sometimes a large number of digital inputs will need to be sampled. Since we are using a microcontroller in our tag, there is a wide range of options available to achieve this. We must always keep current consumption in mind since all our energy is ultimately derived from the transmit coil. A simple

option is to use a shift register to perform parallel-to-serial conversion. **Figure 10** shows a circuit that can be connected to K1 on the RFID board.

### RFID with two ADCs

The ATtiny13 has two analogue-to-digital converters, which makes it possible to build RFID tags that can measure a voltage wirelessly. The software package includes a version of the code that performs conversions on two analogue inputs and returns

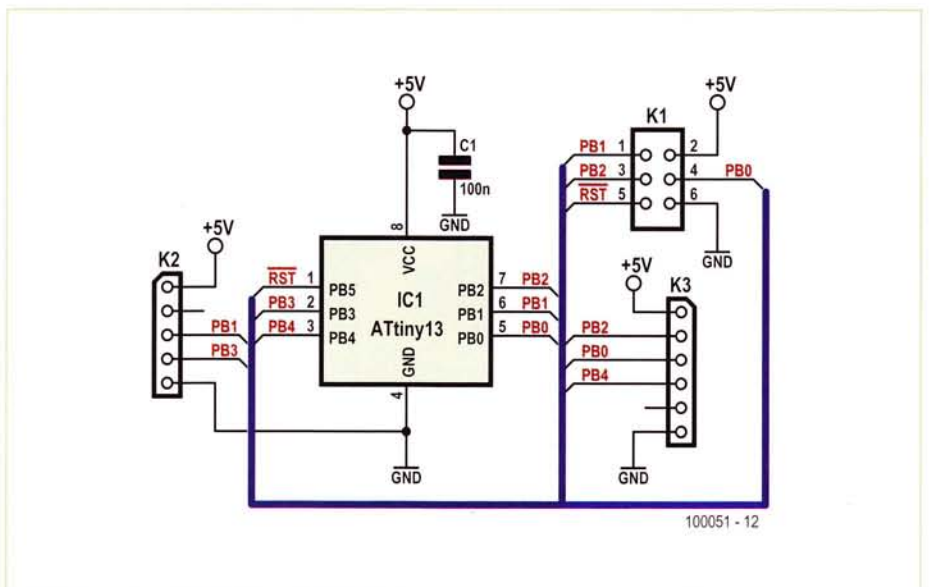

Figure 12. Circuit of adaptor for programming and debugging the ATtiny13 microcontroller.

## COMPONENT LIST: Programmer / Debug Adapter

### Capacitors

C1 = 100nF

### Semiconductors

IC1 = ATtiny13-20PU (for programming / debugging)

### Miscellaneous

K1 = 6-pin (2x3) pinheader  
 K2 = 5-pin right-angled pinheader  
 K3 = 6-pin right-angled pinheader  
 PCB # 100051-2\*

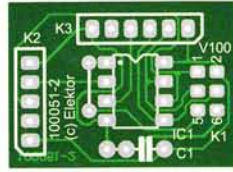

Figure 13. Component mounting plan for the adaptor board.

the values via the ID code to the reader. The reference voltage used is the supply voltage to the ATtiny13, which has both advantages and disadvantages: for example, if it is desired to read the position of two potentiometers, these can simply be connected across the supply to the ATtiny13 with the wiper taken to the analogue input. The result is that the conversion result is independent of supply voltage as the measured voltage rises and falls proportionally with the supply: a so-called 'ratiometric' conversion.

Two accelerations can be measured using a type MMA7260 sensor, which provides ratiometric voltage outputs. In other cases a Zener diode or small 3.3 V regulator should be used to provide a supply to both microcontroller and sensor.

When measuring absolute voltages there is always the problem that the supply to our RFID tag, and hence the reference voltage, depend on the distance to the reader. One option is to use a low-power reference such as the LM385 to provide a known voltage (such as 2.5 V) to one ADC channel, and use this to measure the supply voltage. The second channel can then be calibrated and a precise measurement can then be made.

### RFID temperature sensor

Our final example illustrates the connection of a Dallas/Maxim DS1820 temperature sensor using its one-wire interface. This interface is easy to implement in software, although it is rather slow. The microcontroller in the RFID tag must stop responding to the reader while it is talking to the DS1820 temperature sensor.

This is not a problem for the reader, which is simply forced to wait a little longer for the packet preamble. After the communication with the sensor IC is complete the temperature value is converted to a decimal value, which is then formatted into the ID code. Hence the RFID sensor provides the temperature value almost as 'plain text'. **Figure 11** shows how the DS1820 is connected to the RFID board. In principle the software can be adapted to handle several temperature sensors or other one-wire ICs.

## Internet links

- [1] ATM18 = RFID Savvy, Elektor June 2009  
[www.elektor.com/080910](http://www.elektor.com/080910)
- [2] Experimental RFID Reader, Elektor September 2006  
[www.elektor.com/060221](http://www.elektor.com/060221)
- [3] EM4095 RFID reader IC  
[www.emmicroelectronic.com/webfiles/product/rfid/an/an404.pdf](http://www.emmicroelectronic.com/webfiles/product/rfid/an/an404.pdf)
- [4] EM4102 datasheet  
[www.emmicroelectronic.com/webfiles/product/rfid/ds/em4102\\_ds.pdf](http://www.emmicroelectronic.com/webfiles/product/rfid/ds/em4102_ds.pdf)
- [5] 'RFID made easy'  
[www.emmicroelectronic.com/webfiles/product/rfid/an/an411.pdf](http://www.emmicroelectronic.com/webfiles/product/rfid/an/an411.pdf)
- [6] Elektor project page for this article  
[www.elektor.com/100051](http://www.elektor.com/100051)
- [7] RFID principles of operation  
[www.emmicroelectronic.com/webfiles/product/rfid/an/wireless.pdf](http://www.emmicroelectronic.com/webfiles/product/rfid/an/wireless.pdf)

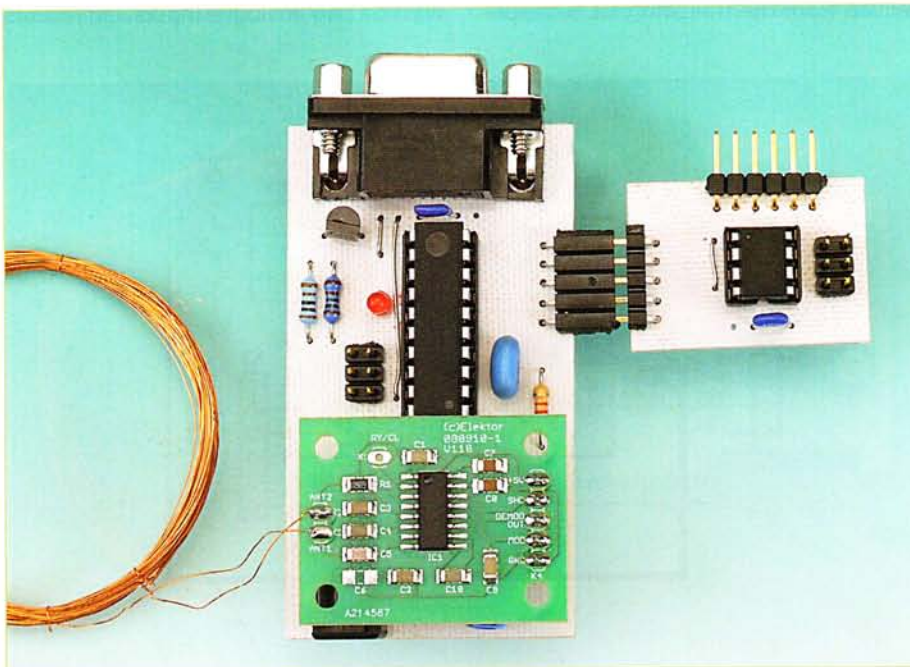

Figure 14. The adaptor board can be connected directly to the reader board using its header for testing purposes.

**RFID sensor debugging**

The examples we have discussed above show how it is possible to build an RFID tag yourself. When developing your own applications testing and debugging must always be kept in mind. The simplest approach is to use the ISP interface. However, this has the disadvantage that the microcontroller in the tag will not have enough energy available from the coil to allow programming, and for this reason the adaptor cir-

**Table 1. Inductance of circular air-cored coils**

D/mm	d/mm	N	L/ $\mu$ H (calculated)	L/ $\mu$ H (measured)
50	0.25	100	1050	1000
50	0.25	75	608	577
50	0.25	40	184	170
25	0.12	150	1143	1000
25	0.12	100	529	470
25	0.12	80	346	310
25	0.12	75	306	273
23	0.12	80	313	275
20	0.12	100	405	360
30	0.12	50	175	160
100	0.25	65	1047	1130
D = coil diameter		d = wire diameter	N = number of turns	

**Listing 2. Interrupt service routine for encoding using PWM**

```

.org 3 ; timer 0 overflow jumps here
TIM0OV:
sbi PORTB,0 ; flag start of interrupt routine
in SREGsave,SREG ; save status
cbi PORTB,0 ; end of test pulse
andi IntBit,1 ; test that bit
brne DOone ; and go to DOzero or DOone
DOzero:
out TCCR0A,PWMmode1 ; clear OC0B on compare match, set OC0B at TOP
ldi IntMail,1 ; flag as fetched
out SREG,SREGsave ; restore status
reti
DOone:
out TCCR0A,PWMmode0 ; set OC0B on compare match, dlear OC0B at TOP
ldi IntMail,1 ; flag as fetched
out SREG,SREGsave ; restore status
reti
    
```

cuit shown in **Figure 12** was developed. The ATtiny13, which contains the RFID and sensor software, can be programmed over its ISP interface (K1 on the adaptor board in **Figure 13**), and the same sensors can be connected to K3 on this board as to K1 on the RFID board. Header socket K2 on the adaptor is connected to K4 on the reader board, and the reader then supplies the ATtiny13 with its 125 kHz clock and processes the data stream output by it on port pin B.1. This arrangement makes it easy to test new RFID sensor software.

(100051)

**Table 2. Data format used by EM4102 RFID tag IC**

preamble	1	1	1	1	1	1	1	1	1
customer id					0	0	0	0	0
					1	1	1	1	0
data0					0	0	0	1	1
data1					0	0	1	0	0
data2					0	0	1	1	0
data3					0	1	0	0	1
data4					0	1	0	1	0
data5					0	1	1	0	0
data6					0	1	1	1	1
data7					1	0	0	0	1
columnparity					0	1	1	0	0

# High Speed Flash Trigger

## A photo flash controller using the ATM18 or Minimod18



Photos: Markus Schilder

By Burkhard Kainka and Wolfgang Rudolph (Germany)

Photography and electronics make good companions. If you want to photograph fast events with high time resolution, you can't manage without a sophisticated flash controller. Photos of moving objects, such as a droplet falling into water, are especially popular.

Photos of falling water drops require precise control of the time when the photo is taken. If you want to control a flash unit, you first need a suitable event and then a time delay. Experiments with interrupting a light beam proved that this approach is difficult, which

led us to the idea of using an acoustic signal to trigger the flash. A piezoelectric transducer can be used as the microphone, either immersed in the water (in a watertight package) or attached to the bottom of a flexible container. The control

tasks are handled by the ATM18 board, equipped with an ATmega88 microcontroller and Bascom control software. You have the choice of triggering a single flash or a series of three flashes. A simple stroboscope mode, which generates a continuous

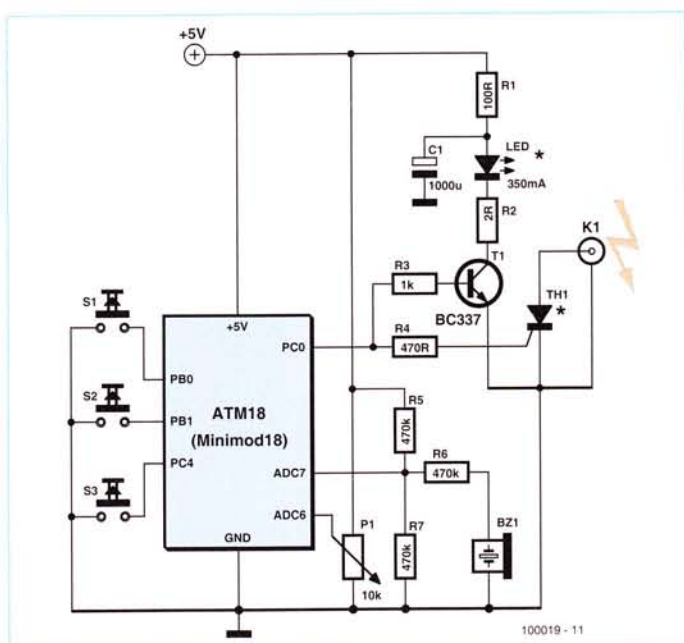

Figure 1. Flash trigger circuit with a piezoelectric transducer for sensing sound waves or vibrations.

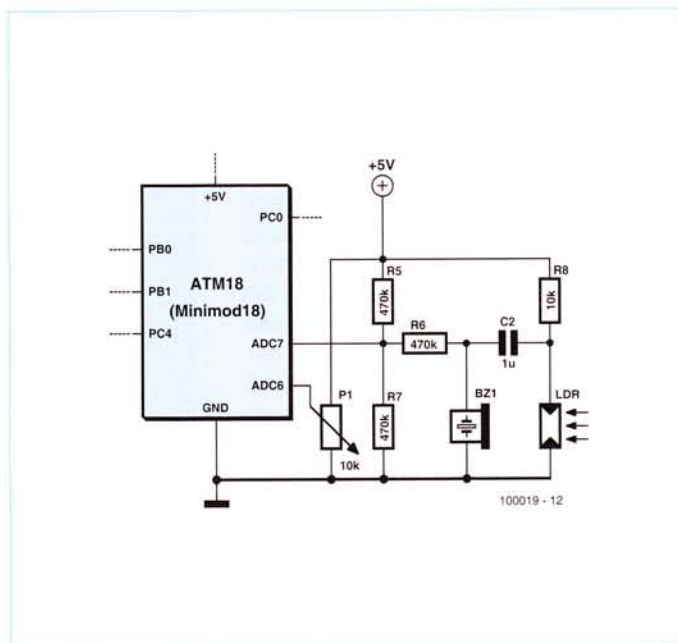

Figure 2. An LDR can also be connected to act as a supplementary light sensor.



## Features

- Photo flash control using acoustic or light signals
- Controls a flash LED and/or conventional flash unit (using either a thyristor or a triac)
- Adjustable trigger delay (100 ms max.)
- Selectable single-flash and triple-flash modes
- Stroboscope mode
- Circuit and firmware suitable for use with ATM18 and Minimod18
- Bascom software with source code (open source for DIY modifications)

series of flashes with adjustable flash rate, also allows the circuit to be used for other applications. These light effects can be put to good use not only for photography, but also for entirely different purposes such as scientific or engineering experiments and light shows.

### Mini circuit

As you can see from **Figure 1**, port C0 (PC0 pin) of the ATM18 provides the control signal for an LED and a thyristor. For your initial experiments, you can use a 1-watt power LED (such as a Luxeon Lumiled) as a flash source. The necessary energy comes from a 1000- $\mu$ F electrolytic capacitor charged via R5. The transistor (a BC337) has a high pulse current rating (800 mA maximum) and can easily drive the LED. With a value of 100  $\Omega$  for R1, it takes approximately 100 ms to fully charge the capacitor. A faster flash rate can also be used, at the cost of reduced brightness. An LED flash has the advantage that a separate power supply is not necessary, and in particular that it does not require a high voltage.

In addition to the LED stage, the PC0 signal is connected to the gate of a thyristor via R4 so that it can be used to trigger a 'real' flash unit. This also works with older-model flash units that operate with a high trigger voltage. Modern units operate with a lower trigger voltage, although the specifications vary considerably from one unit to the next. Before connecting a flash unit to the circuit, you should examine its specifications carefully. The thyristor used here must have a sufficiently high working voltage and a low trigger current (less than 10 mA). The readily available TIC106D, for example, has a 400 V blocking voltage and requires a trigger current of only 0.2 mA. If you use a triac, you can also switch a negative voltage on the trigger input of the flash unit. In our prototype circuit we used a 2N6073 triac (400 V rating), which can also be triggered with a 470- $\Omega$  gate resistor because it requires a trigger current of only 5 mA.

In addition to the circuit diagram, **Table 1** lists the signals used by the control circuit. Potentiometer P1 is connected to A/D converter input AD6 in order to set the time

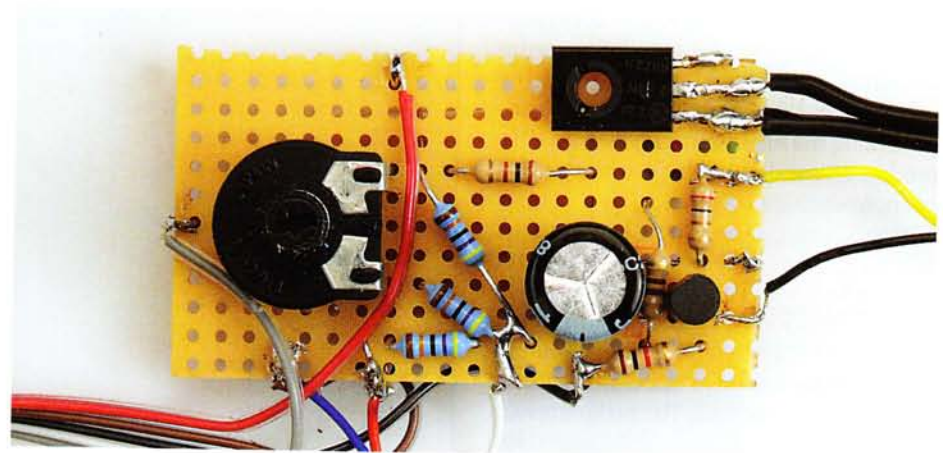

Figure 3. The expansion circuitry built on a piece of prototyping board.

delay or flash rate (in flash mode or stroboscope mode, respectively), and the piezoelectric acoustic transducer is connected

to the AD7 input. The circuit is also suitable for connection to the Minimod18 (see **Table 2**).

**Table 1. ATM18 signal connections**

Signal (on ATM18 Board)	connected to
PB0	Button S1 (ATM18 board K8, pin 1)
PB1	Button S2 (ATM18 board K8, pin 2)
PC4	Button S3 (ATM18 board K8, pin 3)
PC0	R3 and R4 (flash control circuit)
AD6	P1 (flash control circuit)
AD7	Piezoelectric transducer (flash control circuit)
+5 V (K4)	+5 V (flash control circuit)
GND (K3)	Ground (flash control circuit)

**Table 2. Minimod signal connections**

Signal (pin) (Minimod18, connector K1)	connected to
PC4 (pin 7)	Button S1 (external; see Minimod18 inset)
PC0 (pin 5)	R3 and R4 (flash control circuit)
ADC6 (pin 3)	P1 (flash control circuit)
ADC7 (pin 4)	Piezoelectric transducer (flash control circuit)
+5 V (pin 2)	+5 V (flash control circuit)
GND (pins 9 & 10)	Ground (flash control circuit)

Software and operation

The basic functions of the software (see **Listing**) are selected and executed using pushbuttons S1–S3. A ‘long press’ on button S1 selects the Strobo (stroboscope) subroutine, which generates a continuous series of flashes with an adjustable flash rate. The value of the ‘Time’ potentiometer as measured using the AD6 input is divided by 10 to produce a time delay with a maximum value of approximately 100 ms.

Button S2 selects the Trigger1 subroutine. The A/D converter delivers a 10-bit output with a maximum value of 1023. The program runs in a loop for detecting an acoustic pulse signal. The voltage on the AD7 input is 2.5 V in the quiescent state, which yields an output value of 512. The program subtracts 512 from the output value and takes the absolute value of the result, so it doesn’t matter whether the pulse is positive or negative. The program exits the loop when an acoustic pulse greater than 350 is measured. This is followed by the flash delay and then the actual flash pulse, with a pulse width of 1 ms. After the trigger is armed by briefly pressing S2, the program can in principle wait in the polling loop indefinitely until the desired event occurs. You can exit this loop at any time by pressing S1, which puts the circuit back into stroboscope mode.

Button S3 selects the Trigger3 subroutine. It differs from the Trigger1 subroutine in that it generates a series of three flashes.

It’s best to try out the circuit first with a few ‘dry run’ experiments, which means without water. Place your ‘experimental setup’ (ATM18 board and connected circuitry) on a table in darkened room, and put a roll of solder on top of the piezoelectric transducer to ensure good acoustic coupling with the table. Then you can trigger a flash of light (after the set time delay) by dropping something on the table, such as a roll of electrician’s tape. The roll will appear to be floating above the table when the flash is triggered, since it rebounds a short distance above the table after the impact. You can play around with the delay time to vary the apparent floating height.

Experiments

Once you start experimenting with this device, it’s usually hard to stop. In some sit-

Listing

```
'ATM18/Minimod18 Flash Trigger and Strobelight

$regfile = "m88def.dat"
$crystal = 16000000

Dim Delaytime As Word
Dim Trigger As Integer

Declare Sub Strobo
Declare Sub Trigger1
Declare Sub Trigger3

Config Adc = Single , Prescaler = 64 , Reference = Avcc

Config Lcdpin = Pin , Db4 = Portd.4 , Db5 = Portd.5 ,
Db6 = Portd.6 , Db7 = Portd.7 , E = Portc.1 , Rs = Portc.2
Config Lcd = 16 * 2
Ddrc.3 = 1                                'R/W LCD = 0

S1 Alias Pinb.0
S2 Alias Pinb.1
S3 Alias Pinc.4
Out1 Alias Portc.0

Ddrc.0 = 1
Portb.0 = 1
Portb.1 = 1
Portc.4 = 1

Initlcd
Cls
Locate 1 , 1
Lcd "Minimod"

Do
  Locate 2 , 1
  Delaytime = Getadc(6)
  Delaytime = Delaytime / 10                '0...102 ms
  Lcd Str(delaytime) + " ms "
  Waitms 200
  If S1 = 0 Then Strobo
  If S2 = 0 Then Trigger1
  If S3 = 0 Then Trigger3
Loop

Sub Strobo
  Do
```

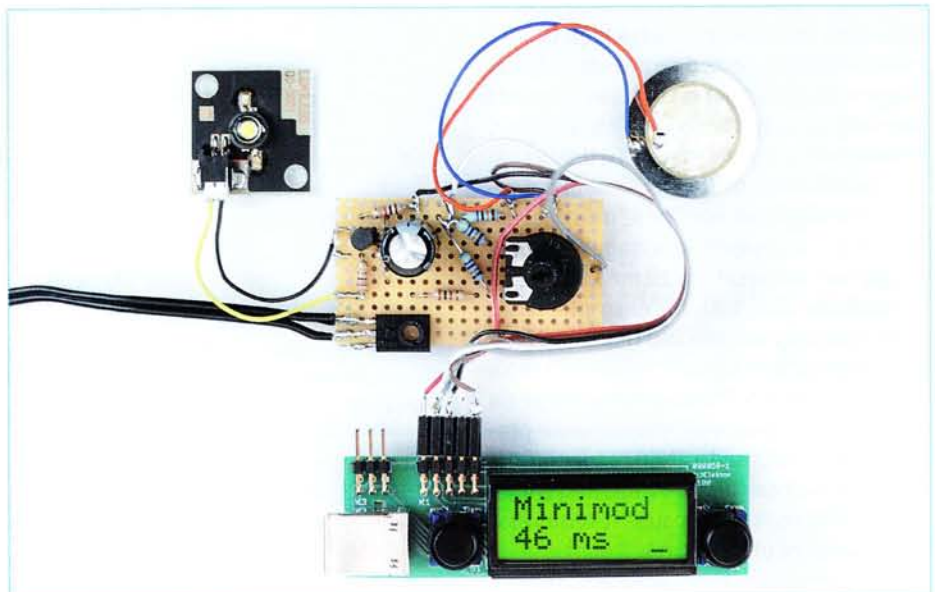

Figure 4. The power and signal leads of the flash trigger circuitry are wired to a socket header (2x5), which can be connected directly to K1 of the Minimod18.

```

    Delaytime = Getadc(6)
    Delaytime = Delaytime / 10          `0...102 ms
    Out1 = 1
    Waitms 1
    Out1 = 0
    Waitms Delaytime
  Loop Until S1 = 1
End Sub

Sub Trigger1
  Delaytime = Getadc(6)
  Delaytime = Delaytime / 10          `0...102 ms
  Do
    Trigger = Getadc(7)
    Trigger = Trigger - 512
    Trigger = Abs(trigger)
    If S1 = 0 Then Trigger = 200      `End by S1
  Loop Until Trigger > 50
  Waitms Delaytime
  Out1 = 1
  Waitms 1
  Out1 = 0
End Sub

Sub Trigger3
  Delaytime = Getadc(6)
  Delaytime = Delaytime / 10          `0...102 ms
  Do
    Trigger = Getadc(7)
    Trigger = Trigger - 512
    Trigger = Abs(trigger)
    If S1 = 0 Then Trigger = 200      `End by S1
  Loop Until Trigger > 50
  Waitms Delaytime
  Out1 = 1
  Waitms 1
  Out1 = 0
  Waitms Delaytime
  Out1 = 1
  Waitms 1
  Out1 = 0
  Waitms Delaytime
  Out1 = 1
  Waitms 1
  Out1 = 0
End Sub

End

```

## Minimod18

The circuit and software are designed such that they can be used with the ATM18 board (ATmega88 MCU) or the Minimod18 (ATmega328 MCU). All necessary signals are available on pin header K1 of the Minimod18, while with the ATM18 board they are available around the microcontroller (see Tables 1 and 2). However, there are a few minor differences.

The Minimod18 has an LCD module, and it would be shame not to use it. Accordingly, the Bascom software writes the delay time setting to the display. Note that the R/W pin of the display module is connected to PC3, which the Bascom software does not service automatically. The software must pull this output to ground. The ATM18 does not have a display module, so the display driver simply operates in a vacuum without causing any detrimental side effects.

With the ATM18 board, the three push-buttons S1–S3 are connected to the microcontroller by wire jumpers. The Minimod18 already has two buttons on the PCB, and the flash trigger software uses them as S1 and S2. If it is also desired to have S3 available, an external pushbutton can be connected to PC4.

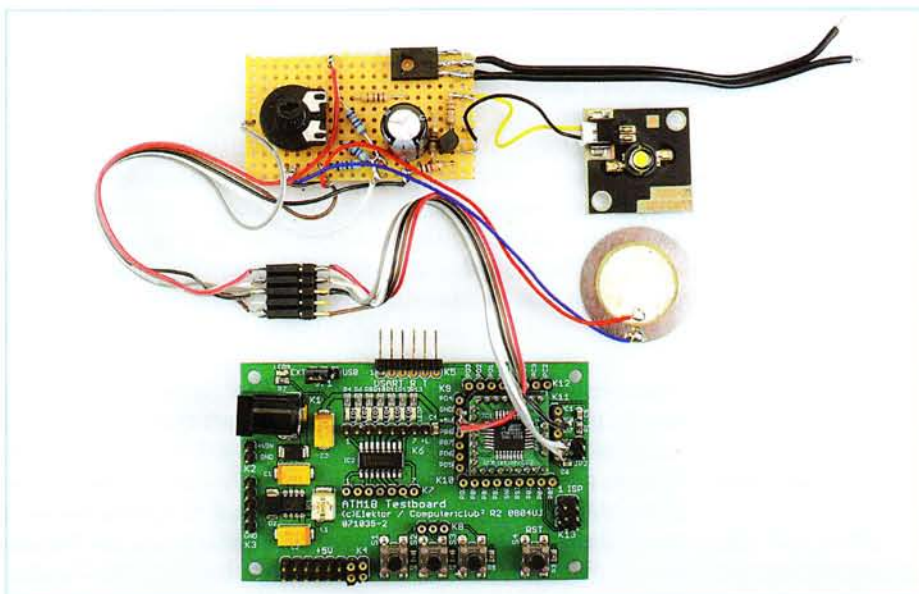

Figure 5. Here the signal points on the ATM18 board have been wired to a 2x5 pin header that mates with the socket header of the flash trigger circuit.

uations, it may be useful to trigger the flash with a light sensor. Among other options, you can use an LDR for this purpose.

With the implementation shown in **Figure 2**, the trigger circuit responds to positive or negative light pulses in the same way as it responds to an acoustic signal, with the further advantage that laborious adjustment of the operating point is not necessary. Here the operating point is set automatically thanks to the use of AC coupling with a capacitor. The trigger circuit responds to a reduction in the amount of light falling on the sensor (such as interrupting the light beam) or an increase in brightness.

With this circuit fitted near an outside window, you can automatically snap a mug shot of any would-be burglar who explores around the window with a pocket torch.

(100019-1)

# DMX512 Control Interface

## With visual configuration using a Cypress PSoC microcontroller

By Markus Wagener (Germany)

The DMX512 protocol is a professional standard for controlling lighting equipment. However, truly general-purpose DMX driver interfaces are far from cheap. This circuit provides a wide variety of outputs and is based on a PSoC device that supports visual configuration. This makes it very easy to generate the desired setup.

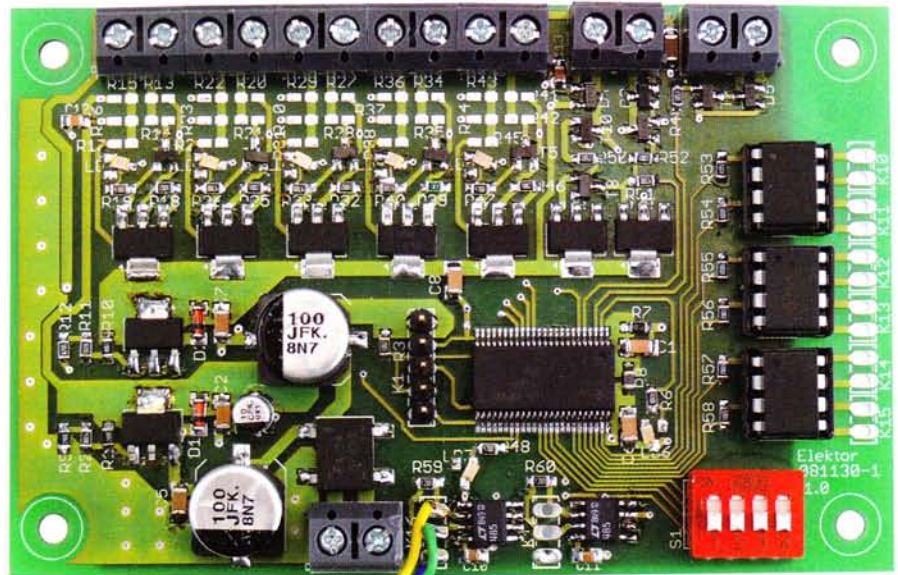

Regardless of whether you're putting on a private party or organising a major festive event, you need the right lighting as well as the right sound to set the right mood. The DMX512 protocol has become established among professionals as the standard for controlling all types of lighting devices. It is based on a RS485 bus with periodic transmission of control bytes for up to 512 channels [1],[2]. Even a large number of devices can be controlled using a single cable. The operator interface for this system can be a light mixing board, but a more economical solution is an inexpensive DMX USB interface (such as the Elektor design [3]; see **Figure 1**) in combination with the free DMXControl PC program [4].

These undeniable advantages convinced the author that what he needed for controlling DIY lighting systems was a truly inexpensive control interface that could be operated via DMX512. Unfortunately, most of the available units that he found provided only 5-V outputs without PWM capability. The author regarded this as far from adequate, especially considering that he also has devices that require a 10-V control signal. A few floating switch outputs would also be nice, along with an output for driving a DC motor (with clockwise and anti-clockwise rotation). The icing on the cake would be a fan control function.

The author quickly decided to develop his own design for a circuit meeting these specifications. Naturally, a general-purpose control interface of this sort requires flexible configuration and programming capability, but this should be fast and simple and should be possible without elaborate additional hardware. Accordingly, the author

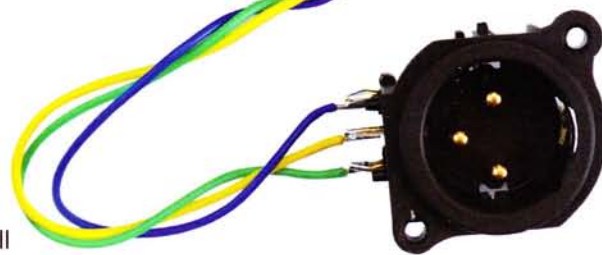

decided to build the control interface around a Cypress PSoC microcontroller, which can be programmed visually using the free PSoC Designer program. As the development environment already contains many ready-made and tested modules (including a DMX512 receiver), putting together a suitable program is truly child's play. The inexpensive MiniProg USB programmer [5] can be used to download the firmware to the PSoC IC. A kit containing the programmer, a test board, a USB cable and software is available from various distributors including Farnell, for around £15 / € 20 [6].

### The circuit

**Figure 2** shows the schematic diagram. The supply voltage at X2 may be provided by a DC supply or an AC supply. The allowable input voltage range is 13–18 V DC or 9–12 V AC. The two supply voltages needed by the circuitry (5 V and 10 V) are generated by a pair of LM317 adjustable voltage regulators. If necessary, the voltage on the higher-voltage supply rail (10 V with the present design) can be adjusted by altering the values of resistors R11 and R12. This could for example be necessary if you need to connect a device with a 12-V control input.

The input connector for the DMX signal (usually a 3-way or 5-way

## Features

- Versatile output configuration
- Visual microcontroller configuration
- Free development environment
- DMX512 input
- DMX512 output (feedthrough or repeater)
- DMX status LED
- 4-section DIP switch for configuration settings
- Temperature sensor for fan control
- Supply voltage range 13–18 V (DC) or 9–12 V (AC)

male XLR connector) is wired to K16. One of the main advantages of the DMX standard is that multiple devices can be connected in series in a daisy-chain configuration. For this reason, the received signal is output on connector K17, to which a female XLR connector can be attached. Note that the pin numbering on the PCB matches the pin designations of the XLR connectors. The interface is implemented as a repeater to ensure that the DMX signal is transmitted with the highest possible reliability. This has the advantage that both ends of the cable are terminated according to spec, and it also means that the signal is regenerated when it passes through this stage. This allows more devices to be connected and enables longer transmission distances. If you wish to omit this feature, you can simply use wire jumpers to route the DMX signals from the input connector to the output connector. In this case, components R59, R60 and IC4 should be omitted.

## Outputs

Five configurable outputs (K3–K7) are available on the PCB. Each output has a status LED for visual monitoring. As you can see from **Figure 3**, the following configurations are possible depending on how you fit the jumpers at locations A to E:

- **open-collector switch** with pull-up to +5 V (A and D)
- **open-collector switch** with pull-up to +10 V (B and D)
- **high-side switch** from +10 V to GND (C and E)

All outputs can be driven in PWM mode as required, which makes dimming effects and much more possible. Naturally, resistors (such as a series resistors for LEDs or current limiting) can be used in place of the jumpers.

To allow the control interface to be used for the greatest possible variety of applications, **six floating outputs** are available (EFF1–EFF6 on K10–K15). These outputs are driven by ASSR-4128-002 solid-state relays. Their advantages relative to mechanical relays are shorter switching times (cycle rate > 100 Hz) and wear-free operation. The maximum load current per channel is 100 mA, which is more than adequate for control tasks.

Output K8 is provided for **driving a DC motor**. The options here are motor off, clockwise rotation, and anti-clockwise rotation. To ensure that both directions are not accidentally selected at the same time (which would cause a short circuit), the signals for the two rotation directions are interlocked via T8. The motor is powered from the 10-V supply rail. The maximum allowable load current is 500 mA.

A voltage divider consisting of resistor R7 and PTC thermistor R8 provides a temperature-dependent voltage. With the aid of the A/C converter integrated in the PSoC IC, this voltage can be used as

## Outputs:

- 1 fan (motor) drive
- 1 DC motor drive with bidirectional rotation
- 5 configurable outputs (with separate status LED for each channel):
  - Open collector (with pull-up to 5 V or 10 V)
    - switch, pulse or PWM mode
  - Hi-wide switch (10 V)
    - switch, pulse, PWM, or analogue (0–10 V) mode
- 6 floating switch outputs (solid-state relay)

a control signal for **driving a fan**. The circuit includes a separate LED as a status indicator for this. However, in the example program described below the fan is controlled by the states of the switch outputs enabled by the DMX control signal. The fan connected to K9 is powered from the unregulated supply voltage (approximately 12 V).



Figure 1. The Elektor DMX USB interface adapter (with the circuitry contained in the XLR connector) and the free DMXControl software transform an ordinary PC into a light mixing board [3].

If at some later date you want to use speed-controlled fan drive in your system, you may encounter problems with the pin assignments, depending on the specific configuration. For this reason, pins 3 and 41 of the PSoC IC are connected together so the drive signal can come from either of these pins. It is imperative to ensure that only one of these pins is configured as an output at any given time.

The **four DIP configuration switches** can be used for various purposes, such as setting the DMX address or switching between different software configurations.

Last but not least, a **DMX status LED** (D12) indicates whether data is being received.

## Example software

Our example project is designed to receive data on ten DMX channels. The channel assignments are shown in **Table 1**. The configuration switches are not used in this example. You can download the ready-made project files from the Elektor website [7]. To help you

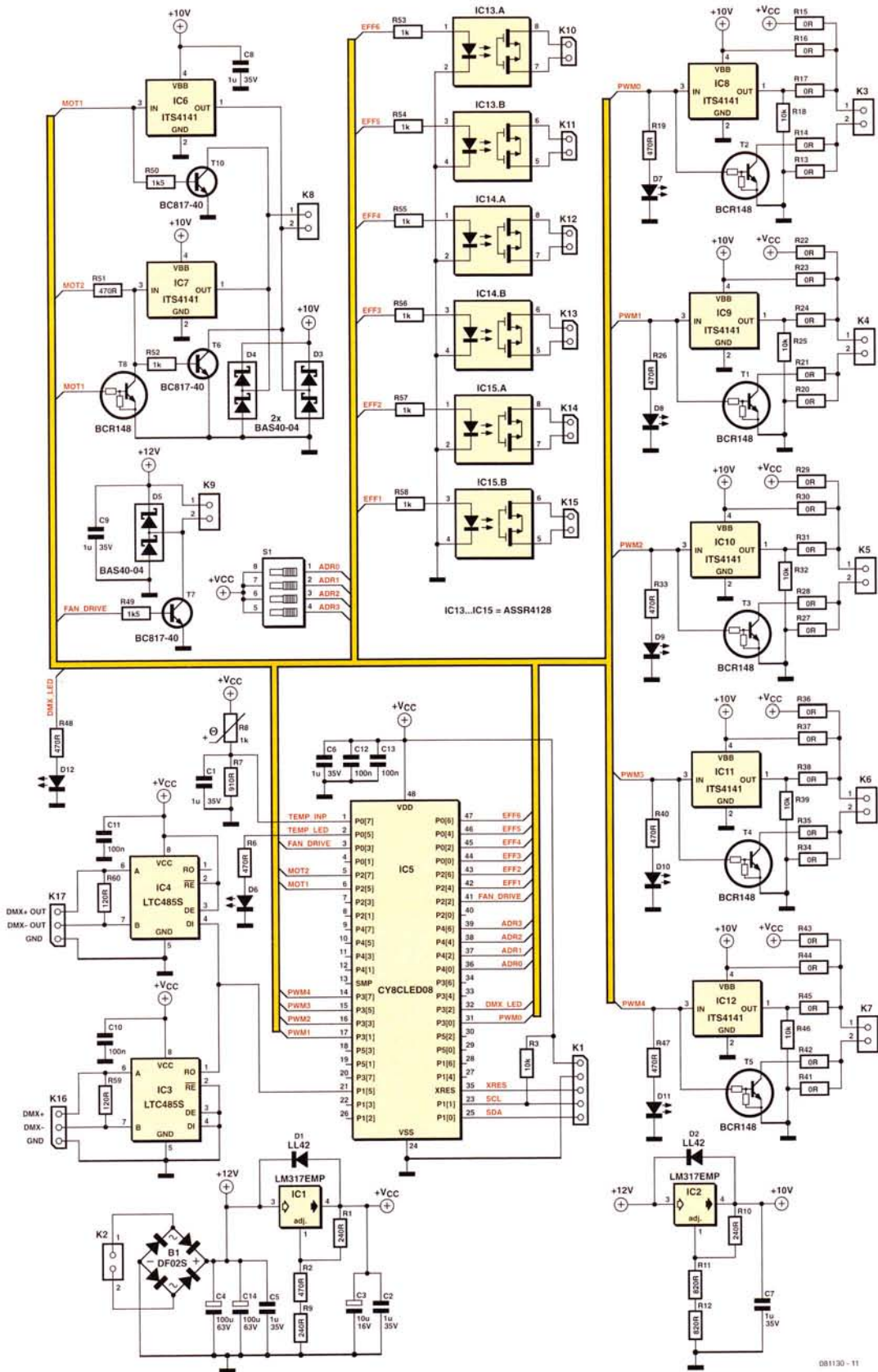

Figure 2. The user-configurable outputs are described in the text. Connector K1 is the programming port for the PSoC IC.

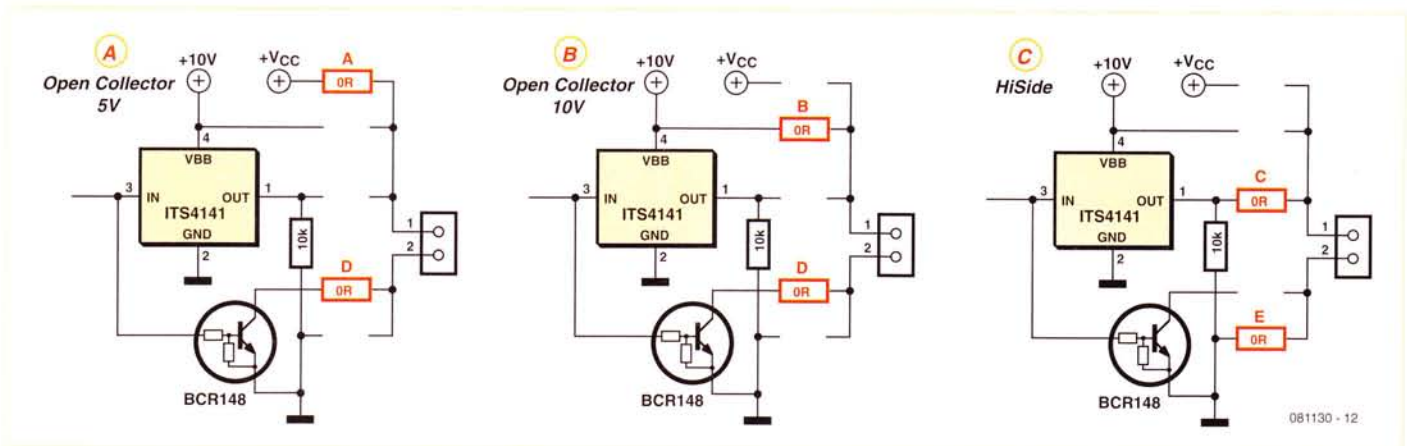

Figure 3. Outputs K3–K7 can be configured in various ways using wire jumpers at locations A, B, C, D and E. The schematic diagram details show outputs configured as open-collector switches with pull-up to 5 V or 10 V and as a high-side switch.

understand how everything fits together and enable you to develop your own software, the development process for this example is described below step by step.

You will need the PSoC Designer 5.0 Service Pack 6 development environment and PSoC Programmer 3.10 (or a later version). Both programs can be downloaded free of charge from the Cypress website [8].

After installing the two software packages, launch PSoC Designer. Then choose 'New Project' on the menu bar, select 'System-level Project', enter a project name (in this case 'DMX1'), and confirm with 'OK'.

An empty design window will appear. A list of predefined modules arranged in function groups appears at the left edge of the window.

Now you can simply drag and drop the necessary modules to the design window, as described below.

- Select 'Valuators' and then 'Interface'. For each of the DMX channels to be received, drag a 'Discrete' module to the design window and define the module name ('V0' to 'V9').
- Under 'Interfaces', select 'Communication' → 'I2C'. Drag a slave to the design window. Define the module designation ('IIC'). This module is necessary for debugging.
- Under 'Interfaces', select 'Communication' → 'DMX512'. Drag a receiver to the design window. Define the module designation ('DMX1'). Specify the module properties (starting slot: 97; number of slots: 10). See Figure 4.
- Under 'Inputs', select 'Digital Input' → 'Banked Input'. Drag an 'InternalPullDown' module to the design window. Define the module designation ('ADR'). Specify the number of bits (4). This module can later be used for address or configuration settings.
- Under 'Outputs', select 'PWM' → 'Variable Duty Cycle'. Drag five 'Vdd, 10 mA High Side' modules to the design window. Define the module designations ('PWM0' to 'PWM4'), initial state (Off), and frequency (8000 Hz).
- Under 'Outputs', select 'Digital Output' → 'DC Switch'. Drag six 'Vdd, 10 mA High Side' modules to the design window. Define the module designations ('EFF1' to 'EFF6') and the initial

state (Off).

These output modules drive the six solid-state relays.

- Under 'Outputs', select 'Digital Output' → 'DC Switch'. Drag two 'Vdd, 10 mA High Side' modules to the design window for the motor driver. Define the module designations ('MOT1' and 'MOT2') and the initial state (Off).
- Under 'Outputs', select 'Digital Output' → 'DC Switch'. Drag one 'Vdd, 10 mA High Side' module to the design window. Define the module designation ('FAN\_DRIVE') and the initial state (Off).
- Under 'Outputs', select 'Display' → 'LED' → 'SingleColor'. Add two 'On/Off with blink' modules to the design. Define the module designations ('TEMP\_LED' and 'DMX\_LED'), BlinkRate (2), CurrentMode (Sourcing), and initial state (Off).

After all the modules have been placed, the design window should look like Figure 5.

## Transfer functions

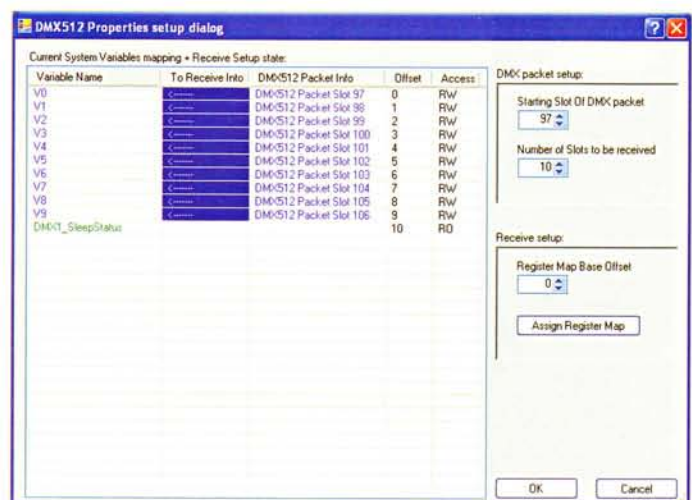

Figure 4. The PSoC Designer package includes ready-made DMX receiver components, and the channel bytes can be stored in variables.

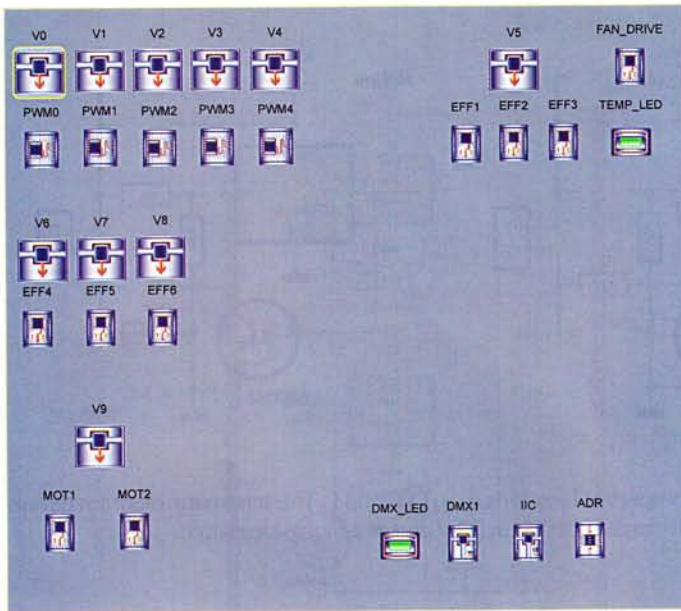

Figure 5. All necessary modules arranged in the design window.

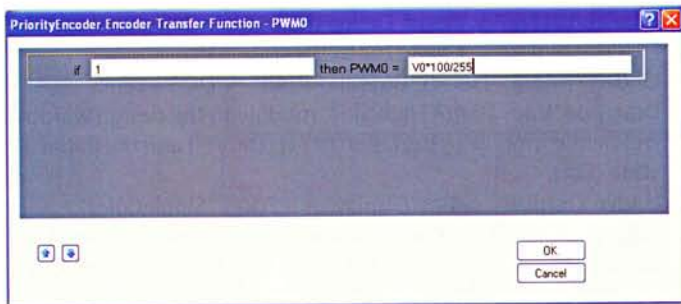

Figure 6. Transfer functions can be defined to determine how the DMX input channels affect the outputs.

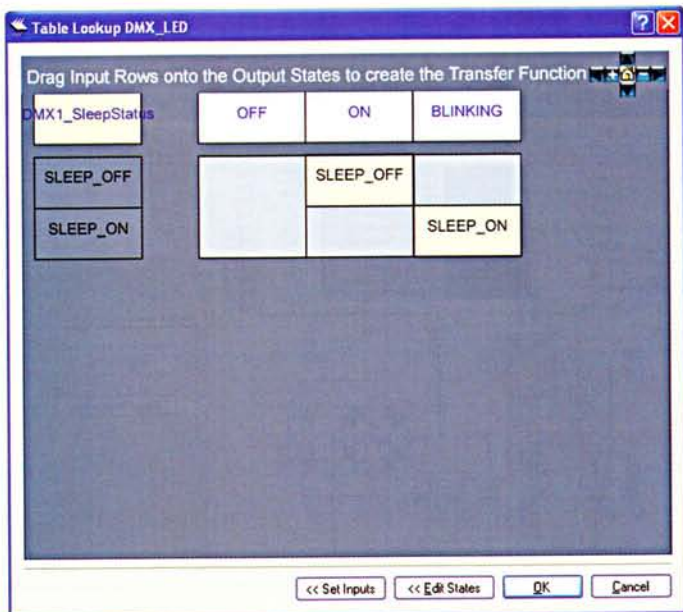

Figure 7. The DMX Status LED should blink when no data is being received.

**DMX channel assignments for the example program**

DMX channel	Value range	Function
97 – 101	0–255	PWM 0–100%
	For general-purpose outputs PWM0 to	
102	0–63	Outputs EFF1, EFF2, and EFF3 Off
	64–127	Output EFF1 On
	128–191	Output EFF2 On
	192–255	Output EFF3 On
103	0–127	Output EFF4 Off
	128–255	Output EFF4 On
104	0–127	Output EFF5 Off
	128–255	Output EFF5 On
105	0–127	Output EFF6 Off
	128–255	Output EFF6 On
106	0–99	DC motor Off
	100–199	DC motor runs clockwise
	200–255	DC motor runs anti-clockwise

The next task is to process the values stored in the valuators by the DMX signal and drive the outputs accordingly. For this purpose, PSoC Designer provides various transfer functions that can be accessed via the context-sensitive menu of the output module concerned.

- The two transfer functions used in this example program are:
- PriorityEncoder for all outputs control by the DMX signal;
  - TableLookup for driving the LEDs.

Let's start by defining the transfer function for the PWM outputs. To do this, open the context-sensitive menu of the appropriate output (by right-clicking the symbol) and select 'Transfer Function... → PriorityEncoder'.

You can enter a condition in the first column of the subsequent dialog (see **Figure 6**). As the output value is calculated unconditionally in this simple example, simply enter '1' here.

In the second column, you enter the formula for calculating the output value. Here the DMX value with a range of 0 to 255 must be converted into a PWM duty factor of 0% to 100%. The corresponding formula is:  $V0 * 100 / 255$ .

Enter the same formula (adapted appropriately for V1 to V4) in the cells for the transfer functions of outputs PWM0 to PWM4.

Next you have to define the transfer function for outputs EFF1 to EFF3. In our example, a single DMX channel (102) is used to drive all of these outputs (see the table of DMX channel assignments). Using the appropriate PriorityEncoder dialog, the DMX value range (0–255) is mapped onto the three digital outputs:



```

EFF1
  if V5<64 then EFF1 = 0
  if V5<128 then EFF1 = 1
  if 1 then EFF1 = 0

EFF2
  if V5<128 then EFF2 = 0
  if V5<192 then EFF2 = 1
  if 1 then EFF2 = 0

EFF3
  if V5<192 then EFF3 = 0
  if 1 then EFF3 = 1
    
```

You may have noticed that the above expressions are sometimes contradictory. This is no problem because the higher-level expression takes priority in each case. This elegantly simple notation saves quite a few '<' symbols.

In our example, the fan is also driven by a PriorityEncoder that depends on the value of V5. The fan should run whenever any of the EFF1–EFF3 outputs is active.

```

FAN_DRIVE
  if V5<64 then FAN_DRIVE = 0
  if 1 then FAN_DRIVE = 1
    
```

The EFF4 to EFF6 outputs are assigned to valuator V6 to V8. As we allow ourselves a DMX channel for each output here, the transfer function is somewhat simpler:

```

EFF4
  if V6<128 then EFF4 = 0
  if 1 then EFF4 = 1
    
```

etc.

The transfer functions for the motor control function take the following form:

```

MOT1
  if V9<100 then MOT1 = 0
  if V9<200 then MOT1 = 1
  if 1 then MOT1 = 0

MOT2
  if V9<200 then MOT2 = 0
  if 1 then MOT2 = 1
    
```

All that's left is to assign a transfer function to the DMX status LED. The LED should light up when DMX data is being received and blink when no data is being received. To achieve this, right-click the DMX\_LED module to open the context-sensitive menu and select 'Transfer Function... TableLookup'.

In the subsequent dialog, select 'DMX\_SleepStatus' as the data source. Now you can use drag & drop to assign the data source values in the left column of the window that opens next to the available LED states. In this case, use the mouse to drag the 'SLEEP\_OFF' status to the 'ON' column and the 'SLEEP\_ON' status to the 'BLINKING' column (see Figure 7).

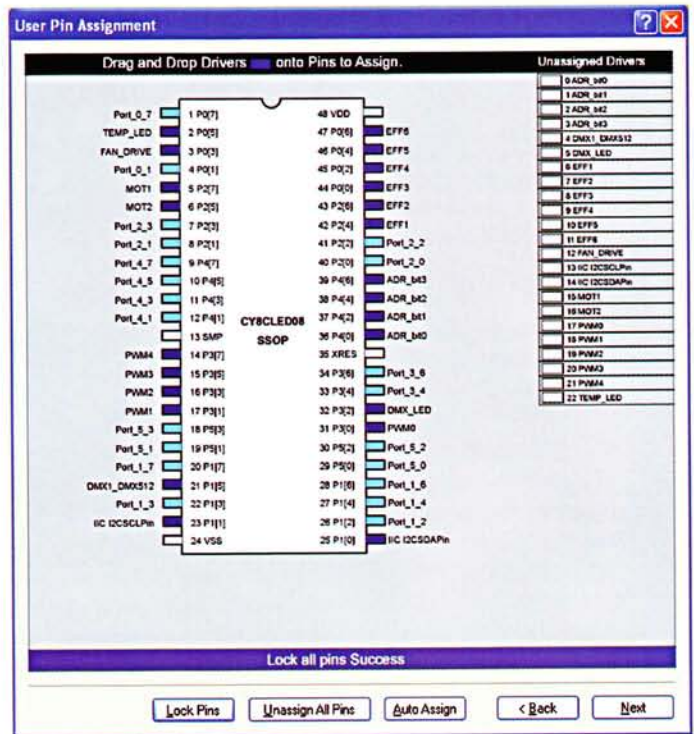

Figure 8. Assigning the individual module signals to the microcontroller pins.

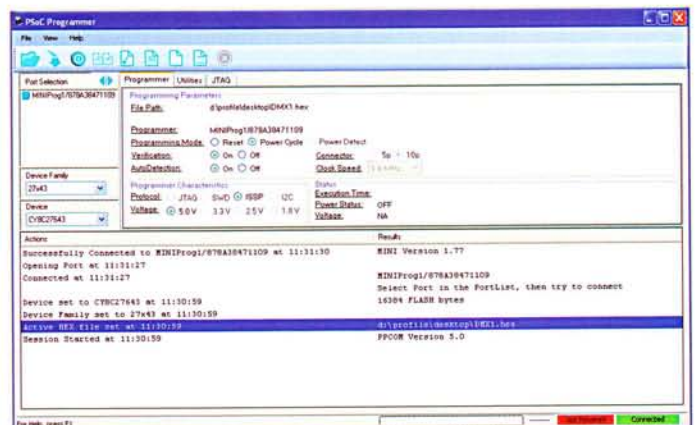

Figure 9. A few settings must be defined before the program code can be downloaded to the PSoC IC.

### Pins and programming

After you have placed all the modules and defined the necessary transfer functions, the next step is to compile the project and load it in the target hardware.

First press key F6 to start the build process. In the window that appears next, select the PSoC type 'CY8CLED08, 48 Pin'. Accept the rest of the settings unchanged.

Click the 'Next' button to proceed to the User Pin Assignment window (Figure 8). The first thing you have to do here is to undo the automatically generated pin assignments by clicking the 'Unassign

## COMPONENT LIST

### Resistors

(all SMD 0805)  
 R1,R9,R10 = 240Ω  
 R2,R6,R19,R26,R33,R40,R47,R48,R51 = 470Ω  
 R3,R18,R25,R32,R39,R46 = 10kΩ  
 R7 = 910Ω  
 R8 = PTC LT731K0JTG (Tyco Electronics)  
 R11,R12 = 820Ω  
 R13,R17,R20,R24,R27,R31,R34,R38,R41,R45 = 0Ω (see text)  
 R14,R15,R16,R21,R22,R23,R28,R29,R30,R35,R36,R37,R42,R43,R44 = 0Ω (see text)  
 R49,R50 = 1.5kΩ  
 R52,R53,R54,R55,R56,R57,R58 = 1kΩ  
 R59,R60 = 120Ω

### Capacitors

C1,C2,C5,C6,C7,C8,C9 = 1μF 25V (1206)  
 C3 = 10μF 16V (4x5.8mm)  
 C4,C14 = 100μF /63V (10x10mm)  
 C10,C11,C12,C13 = 100nF (0805)

### Semiconductors

D1,D2 = BAS285-GS18  
 D3,D4,D5 = BAS40-04  
 D6,D7,D8,D9,D10,D11,D12 = LED (0805)  
 B1 = DF02S  
 T1,T2,T3,T4,T5,T8 = MUN2211LT1G  
 T6,T7,T10 = BC817-40  
 IC1,IC2 = LM317EMP

IC3,IC4 = LTC4855  
 IC5 = CY8CLED08-48PVXI  
 IC6,IC7,IC8,IC9,IC10,IC11,IC12 = ITS4141N  
 IC13,IC14,IC15 = ASSR-4128-002

### Miscellaneous

S1 = 4-way DIP switch  
 K1 = 5-pin pinheader, lead pitch 0.1 in. (2.54mm)

K2,K3,K4,K5,K6,K7,K8,K9 = 2-way PCB terminal block, lead pitch 0.2 in. (5.08 mm)  
 K10,K11,K12,K13,K14,K15 = 2-pin pinheader, lead pitch 0.1 in. (2.54mm)  
 K16,K17 = 3-pin pinheader, lead pitch 0.1 in. (2.54mm)  
 PCB # 081130-1, see [www.elektor.com/081130](http://www.elektor.com/081130)

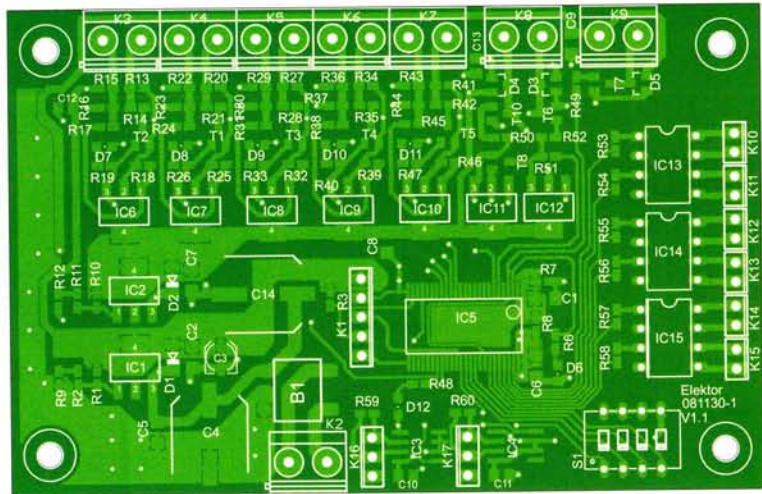

All Pins' button. Then use drag & drop to assign the drivers in the box at the right of the window to the microcontroller pins according to the signal definitions shown on the schematic diagram. After you have completed pin assignments, click the 'Next' button to start the Project Generator. After the project has been successfully compiled, it can be loaded directly into the hardware. For this purpose, you must first connect the programming adapter to the PC and the target hardware (connector K1). A handy feature of this arrangement is that the control interface board does not have to be connected to a power source for programming, since it is powered from the MiniProg adapter. With the adapter connected, the next step is to launch PSoC Programmer, select the MiniProg adapter, and connect to it. Then you can download the program file (DMX1.hex). The following settings must be enabled in order to download the program (see **Figure 9**):

Programming Mode: Power Cycle  
 Verification: On  
 Auto Detection: On

Protocol: ISSP  
 Voltage: 5.0 V

It is especially important that 'Auto Detection' is selected.

PSoC Programmer does not correctly recognise the CY8CLED08 version that is actually used here. Instead, it automatically selects the CY8C27643. This doesn't matter; everything still works OK. Press the F5 key to start the programming process. It takes around 20 seconds to transfer the program, after which the hardware is ready to use.

Naturally, this example project (which has intentionally been kept simple) can easily be modified and extended. In fact, another example project is also available for download [8], along with the configuration described here. It includes features such as delayed fan shut-off and an emergency lighting mode for the PWM outputs that is invoked in case of DMX signal failure.

(081130-1)

## Internet Links

- [1] [www.elektor.com/010035](http://www.elektor.com/010035)
- [2] <http://en.wikipedia.org/wiki/DMX512>
- [3] [www.elektor.com/060012](http://www.elektor.com/060012)
- [4] [www.dmxcontrol.de/downloads/software.html](http://www.dmxcontrol.de/downloads/software.html)
- [5] [www.cypress.com/?rID=3412](http://www.cypress.com/?rID=3412)
- [6] <http://uk.farnell.com/cypress-semiconductor/cy3217/programmer-psoc-miniprogrammer/dp/1472439?Ntt=Cypress+MiniProg>
- [7] [www.elektor.com/081130](http://www.elektor.com/081130)
- [8] [www.cypress.com/?rID=34517](http://www.cypress.com/?rID=34517)

# Two USB scopes and one not so USB

By Luc Lemmens (Elektor Labs) and  
Jan Buiting (Elektor UK & US Editorial)

USB oscilloscopes are wildly popular, they represent a significant market and since 2005 quite a few have been tested and described in Elektor. Probably as an afterburner effect of our most recent comparison of the Velleman and Pico USB oscilloscopes in Elektor's May 2009 edition, we received advice from three companies that they too had a competing product and would E-LABS look at it? While Pico and Velleman are European based, this time the manufacturers were from the USA (Parallax), New Zealand (Cleverscope) and Australia (ScreenScope / Diamond Systems), proving once again that Elektor has truly global coverage. All company representatives were the nicest people you can think of in terms of having them on the phone and actually shipping a sample.

## Cleverscope CS328A



The Cleverscope CS328A is an up range classic USB oscilloscope that's rightly called an "engineer's toolbox" as its functionality goes far beyond that of an oscilloscope displaying two analogue channels on your PC monitor. The actual unit supplied was a CS328A, 12-bit, with CS800 8M memory and CS700A pre-installed. The instrument is housed in an ABS case with dimensions 180 x 150 x 38 mm. It is externally powered by an in-line AC adapter rated 9 V, 2 A. Two probes (X10/X1 switchable) are supplied, as well as two 4-bit digital input pods and a CD-ROM. The software installation is dead easy and follows the usual steps for a USB peripheral. Roger Carter of Cleverscope kindly advised us to pull software version v4.649 (dated 11 Mar 2010) from the Cleverscope website and so we did. Remarkably, and this is from two old time CRT oscilloscope users, Cleverscope on being launched does not take over your screen with the expected image of a bit of noise dancing on the the X/Y graticule and knobs around it, but instead pops up four windows on your desktop: Cleverscope Control Panel, Scope Graph, Signal Generator, and Notes. The Control Panel in particular looks daunting in terms of the multitude of controls available and nothing like the good old 'beam finder' button you'd have on an old style scope!

Fortunately, one of the first tips popping up in the Notes box is to connect the sig gen to Channel A and then press 'Autoset'. It works like magic, there must be lot of computing behind this!

No doubt the 'multiple windows' structure of the Cleverscope software is necessary to support all the features available and enable users to control the instrument to the full extent but it can also be confusing to old school scope users because seeing your carefully set up scope screen with all your complex signals on it disappear at the click of a mouse is alarming. Sure it's all down there in the taskbar ready to pop out again but it's a strange instrument that has no CRT but the Control Panel and the Signal Generator box sitting on your desktop. Plug-in units, okay, but no Tektronix oscilloscope was ever made that way – the scope screen was always there.

Assuming you are familiar with maximizing and minimizing windows, as well as reactivating them from the task bar, operating the CS328A still requires a good deal of getting used to as there are so many small controls to click on or slide up and down. Fortunately, the user manual may be found on the supplied CD ROM

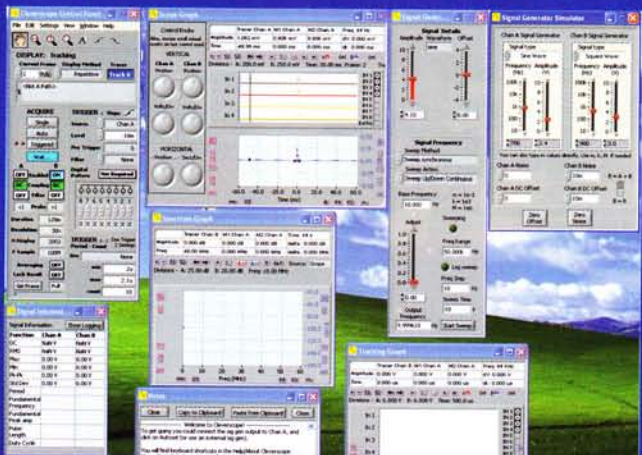

as well as on the Cleverscope website. It is really good, well worth printing and keeping the hard copy within arm's reach. Also, the Scope Graph has an option to display control knobs you can 'turn' with your mouse. The icons above the scope graph are small by our standards even if the window is maximized.

In terms of accuracy, bandwidth and 'toolbox' the Cleverscope is clearly superior to the other two instruments landed on our desk, but that's to be expected having seen the price difference – and then this article is not intended to be a comparative test.

As you spend more time exploring the Cleverscope's features and menus you're bound to become impressed by the power and versatility of the unassuming grey box on your desk. For example, a swept-frequency measurement across a frequency range of 10 Hz through 50 kHz easily revealed spurious burst-like oscillations and even signs of microphony in a tube amplifier with suspected problems. The superimposed bursts could easily be isolated from the output signal, magnified and analysed to determine the frequency (18.5 kHz). This identified an intermittent yet serious intermodulation problem in no time.

Cleverscope have distributors in many countries. In the UK, contact Aspen Electronics.

## Screenscope SSC-A531 — look, no USB!

The last unit to arrive for scrutinizing in our lab was the Screenscope a.k.a. “this-is-not-a-USB-scope”. Happily the unit arrived just before most of the European air space turned a lighter shade of brown with Icelandic volcano dust.

Sure, we know CRT scopes, USB scopes and soundcard “freebie” scopes. Been there, done that. Then suddenly a news item called “this-is-not-a-USB-scope” published in the March 26, 2010 E-weekly newsletter got such high view rates across three Elektor language sites that some curiosity was expressed in the lab. The prospect of NOT having a PC on the cluttered workbench to have an oscilloscope available certainly has its attractions and sure, there’s always an old 17 or 19 inch LCD screen doing 1024 x 768 256-colour 60 Hz VGA and a USB mouse gathering dust somewhere. No PC on the e-workbench means: no risk of dam-

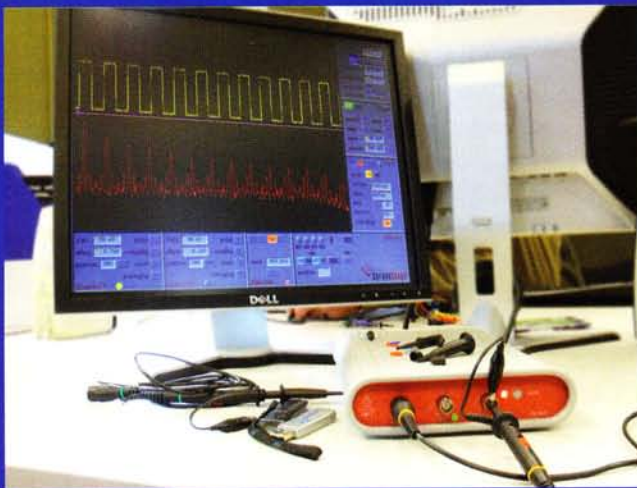

aging it with parts and tools, no noisy hard disk, no flat batteries when the moment of joy arrives, no start up time, no passwords, software installs, crashes, licences, viruses, hacking or emails from the sales department.

In a way the Screenscope is a return to the days of the CRT memory scope but without the weight, size and the small green or blue screen. The big colour screen is definitely what we want. Those rotary controls and wobbly buttons are all gone and replaced by state of the art ergonomics called a USB Mouse (wired or wireless!).

The instrument comes in a silver grey anodized aluminium housing (227 x 160 x 42 mm) with rounded edges and shock absorbing feet. The case we’re sure will withstand a lot of rough handling including acting as a solder iron rest and being run over by a mounting bike no matter at high or low speed.

For sure on the rear panel are two USB sockets, one labelled ‘memory’ and the other ‘mouse’. The first is not just for the obvious purpose of saving waveforms and complete screens to a USB stick, but also for uploading new system software to the instrument, which is described as ‘not normally required’. Screen saving employs the Windows .bmp file format and is painfully slow under USB 1.1.

We were a bit disappointed to see a  $\pm 45$  V (Class I) maximum input voltage specification on the Screenscope but then Jan’s old Tektronix 535 CRT scope and its mighty 1.2 kV probe really shouldn’t be separated from the old tube equipment around it, just because new fangled technology arrives from down under!

Fortunately the X10 probe supplied should extend the input voltage range considerably — at the risk of the user, of course. More importantly the Screenscope is specified as NOT suitable to probe AC powerline voltages, irrespective of the probe used. Luc on the other hand was perfectly happy with the  $\pm 45$  V spec proclaiming that anything above that belongs in the realms of electric engineering, is dangerous and best left to Amps specialists.

Operation out of the box is intuitive and straightforward, except perhaps for the FFT and maths functions but then there’s a classic printed manual with the Screenscope and all’s explained in good detail. Math comprises +, -, x and / operators on channels 1 and 2. The FFT options are Hamming, Hanning, Blackman, Flattop and Rectangular.

Channel 3 has a double function. Depending on your selection it’s a 1-bit channel with a TTL/CMOS voltage threshold of

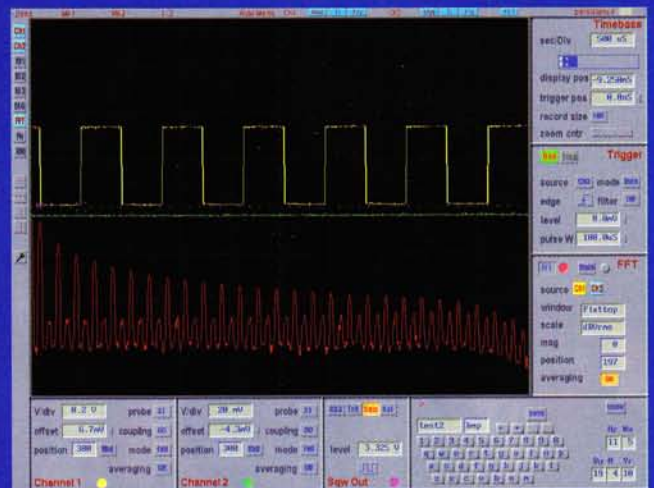

1.65 V, or a trigger source. In trigger source mode it’s also used to calibrate the instrument and help you adjust the well-known compensation trimmer on probes.

Working with the mouse requires a few minutes to get used to. A two-button type with a centre wheel is required. As opposed to some software scopes Harry Baggen was testing for his article, there’s no need to do acrobatic hand and wrist movements to operate the virtual controls, which have been flattened to simple on/off buttons and +/- (up/down) controls for all instrument settings, i.e. no attempt has been made to mimic coloured scope knobs. Markers can be grabbed and dragged into and out of the actual scope screen.

Diamond Systems has only just started to make publicity for their Screenscope product outside their home territory (Australia). Remarkably, they have not defined a euro price for the European market. Instead, everyone in Europe, Africa, India, the USA, China and the Russian Federation is expected to pay in US dollars. Apparently no distributors have been appointed yet.

## Parallax PropScope: small is beautiful

This USB scope in its blue metal case is built around the Propeller chip that’s seen coverage in Elektor on a number of occasions. For sure, the PropScope is the cheapest and most compact of the three scopes discussed here, on the down side, it has the poorest specifications, specially in terms of bandwidth. A function generator, a 4-channel logic analyser and a 4-bit NTSC/

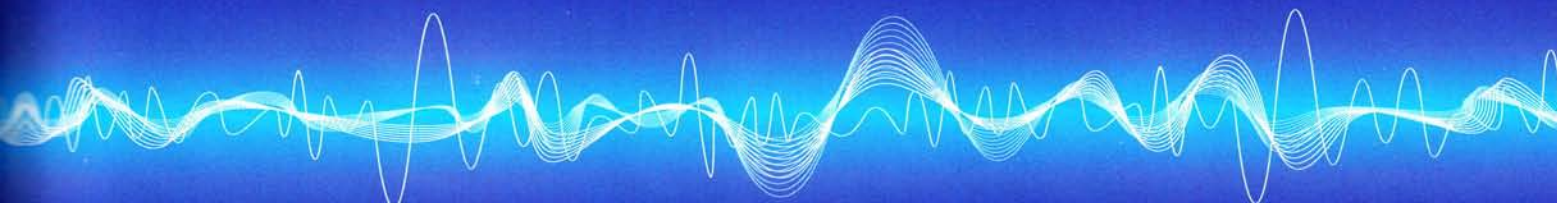

PAL output are contained on an add-on board you can plug into the PropScope. With the board fitted, scope channel # 2 is not available.

The package also contains two nice probes, a Getting Started guide and a USB cable which doubles as the supply cord to the PropScope. The PC software is missing but *whadyathink*, a visit to the Parallax website is the ticket to getting the latest version free of charge and in no time at all. The Help menu also guides you to a more extensive manual: a pdf file that provides deeper explanations of the operation of some of the PropScope's functional components. Sadly, crucial specifications like the scope bandwidth and the function generator's frequency range are not found here either.

Boffins will like to know that the schematic and the firmware tech descriptions may be found on the Parallax website.

know instantly where and how to access the essential controls and that's what counts. It's not just the screen that reminds us of the old benchtop oscilloscope, even your ears are treated to relay clicking if you turn the attenuators.

The plug-in module with its function generator, logic analyser and NTSC/PAL output is a bit of a mystery. For example the documentation is not too clear about the 'composite video signal' supplied and we just didn't feel like hauling in a big TV set to see what the signal is all about.

The generator is capable of supplying standard rectangle, sinewave and sawtooth signals, but the user can also define his/her own output waveform.

Compared to the other two scopes the PropScope is by no means a high end instrument. The few specifications we have are far from spectacular and the ones we need to know are

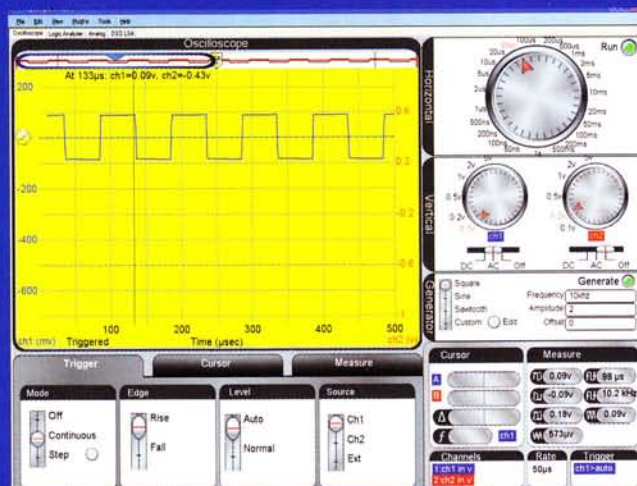

The software installation is simplicity itself. Next, all you have to do is plug in the USB cable and launch the PropScope application on your PC. Instant recognition: this is an oscilloscope with all the familiar controls for timebase, attenuators and trigger source selection. With other USB scopes you are often confronted with a bewildering number of options and a cascade of windows opening when the program is started, making you unsure where to start.

The graphic interface offered by the PropScope may appear Spartan but if you've ever operated a traditional CRT scope you

unclear from the documentation. Still, the PropScope proves the sheer power of the Propeller chip, the price is attractive, as is the case. Its small dimensions make the PropScope ideal for use as a portable measurement system in combination with a laptop PC, while in the normal office or home environment it will prove useful for lots of basic 'scoping tasks. Cute, and always good to have nearby on the workbench!

Parallax have a distributor network. In the UK, contact Milford Instruments or Spinvent.

(100281)

	Cleverscope CS328A	PropScope	Screenscope SSC-A531
Sample rate (MSPS)	100	25	240
Bandwidth (MHz)	100	Not specified	50 (-3dB)
Digitizer(s)	10 / 12 / 14-bit	10-bit	8-bit (Ch. 1 & 2)
Channels	2 analogue, 8 digital	2 analogue	2 analogue, 1 digital
Probe(s) supplied	2 x X10/X1	2 x X10/X1	X1, X10
Price (approx., (excl. P&P and tax). Local price may vary.	from US\$1099 / €879 / UKP887	US\$250	US\$450
Additional instruments	Spectrum Analyser, Tracking-Graph, Multimeter, Function Generator	Logic analyser, function generator, NTSC/PAL o/p (on extension board)	-
website	www.cleverscope.com	www.parallax.com	www.screenscopedtraces.com

# Audio teamwork

By Harry Baggen (Elektor Netherlands Editorial)

Every electronics engineer will be familiar with the maxim "The numbers tell the tale". This may perhaps not be entirely true for audiophiles, because they often prefer to rely on their ears rather than expensive test equipment. Unfortunately, taking measurements of hifi equipment is not that easy either. When making these kinds of measurements you have to ask yourself whether you have measured all the relevant parameters that are responsible for the overall sound quality.

This was the dilemma of Rolf Hähle of the well-known German audio magazine Stereo ([www.stereo.de](http://www.stereo.de)). Rolf is responsible for all the technical measurements of all the equipment that gets tested by the magazine. For this purpose he has a Rohde & Schwarz UP audio analyser available. Based on a documented measuring procedure, all equipment to be tested is subjected to exactly the same measurements under exactly the same conditions. Rolf is a skilled hand at this and the measurements are always very reliable. Incidentally, he acquired part of his knowledge while working for Elektor, where for many years he was the editor of the German Elektor edition and Audio Special Editions.

Recently however, there was a strange phenomenon when he was testing an expensive class-D amplifier. When measuring the distortion — in particular the intermodulation distortion — there appeared many high values. According to the importer it was impossible that the IMD of their amplifier amounted to several percent. They asked for a 'second opinion'. Rolf still has regular contact with the staff at Elektor and he is also familiar with the test equipment that Elektor has at its disposal. So the idea was born to carry out some measurements together in the Elektor lab. A few weeks later he arrived at Elektor House with a few amplifiers (including the problematic one) and his own analyser. Three expensive audio amplifiers, with price tags varying from 5,000 to 11,000 euros, were carefully unpacked in the Elektor lab and prepared for testing, on the one hand, by the R&S UP analyser belonging to Stereo and on the other hand by the renowned Audio Precision System Two Cascade Plus 2722 Dual Domain, an undisputed reference for audio measurements (see photo), belonging to Elektor.

The problem with testing switching amplifiers is mainly related to the switching frequency. Normally this is several hundred kilohertz. The output filter ensures that this signal is suppressed considerably, but a substantial signal may remain nevertheless, which can upset a sensitive measurement. So the initial suspicions of the Elektor designers were that this residual switching frequency noise was responsible for influencing the distortion measurements. We already encountered this problem during the development of the Clarity power amplifier in 2004. At the time we designed and built a special measuring filter (a passive 9th-order Cauer filter), which sharply suppresses all frequencies above 180 kHz. The UP analyser from R&S already has quite a steep filter built in, which has a corner frequency of 100 kHz, so it should experience very few problems with noise from the switching frequency. The AP analyser has a much wider bandwidth and is therefore in more of a need for a good external measuring filter. Fortunately, the filter we built in 2004 was still around.



And now the test results. Unfortunately for Rolf, using the AP analyser we could not obtain better numbers for the IMD measurement of the expensive class-D amplifier. Multiple test arrangements and filter bandwidths were tried, but in most cases the results were even worse than those produced by the R&S analyser. A few follow-up FFT analysis runs showed that the amplifier (or its power supply) had problems when reproducing low frequencies, even at modest power levels. (The screen dump shows the noise spectrum of the amplifier; note the peak at 50 Hz). This resulted in the high IMD values, since the measurement uses a frequency of 8 kHz superimposed on a 4 times bigger signal at 60 Hz.

After doing a few more comparison measurements, we were, in any case, convinced that both analysers were operating very well and that there was nothing wrong with either the test arrangement or the measuring filter. After carefully loading the expensive 'audio wheels' again, Rolf could turn home-wards, an experience richer but unfortunately not with better test results... How was he going to explain that to the manufacturer? In any case, this has been a very interesting and instructive day, both for him and for us!

(100325-1)

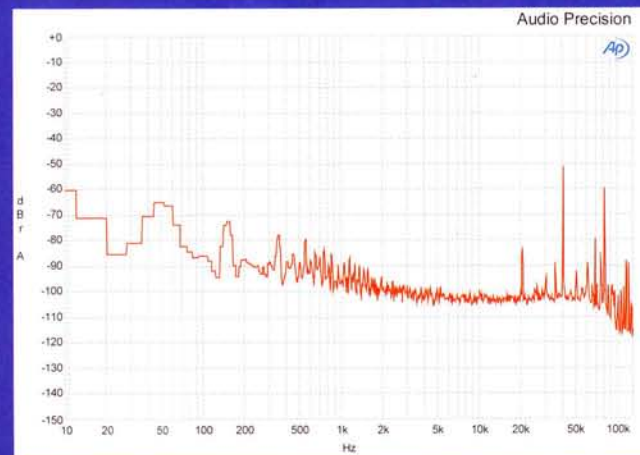

NEW

DISTANCE LEARNING COURSE

# Programming Embedded PIC Microcontrollers

→ using Assembly, C and Flowcode

Special introductory price:  
**£40 | \$70 | € 50 DISCOUNT**  
[www.elektor.com/distancelearning](http://www.elektor.com/distancelearning)

In this course you will learn how to program an embedded microcontroller. We will start with the absolute basics and we will go into a lot of detail. You cannot learn about software without understanding the hardware so we will also take a close look at the components and schematics. At the end of the course you will be able to design your own embedded applications and write the appropriate software for it.



#### Contents:

- Background
- Digital Ports
- Serial Communication (RS232)
- Analog Signals
- Pulse Width Modulation
- Timers/Counters/Interrupts
- Memory
- LCD Display
- I<sup>2</sup>C Communication
- SPI Communication
- USB Communication
- Configuration (Fuses)
- Answers to the assignments
- Appendix

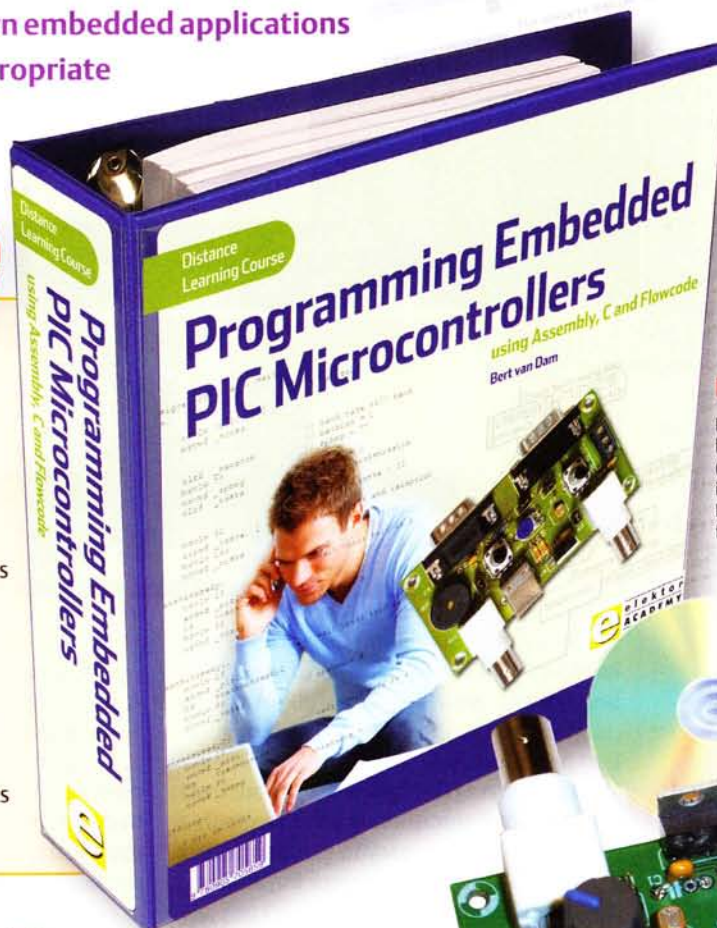

#### Your course package:

- Courseware Ring Binder (747 pages)
- CD-ROM including software and example files
- Application Board
- Support at Elektor Forum
- Elektor Certificate

Price: **£395.00 | \$645.00 | €445.00**

Please note: to be able to follow this course, E-blocks hardware is required which you may already have (in part). All relevant products are available individually but also as a set at a discounted price. Please check [www.elektor.com/distancelearning](http://www.elektor.com/distancelearning) for further information.



Further information and ordering at  
[www.elektor.com/distancelearning](http://www.elektor.com/distancelearning)



# Measuring for Free

## Free measuring software for the PC

By Harry Baggen  
(Elektor Netherlands Editorial)

Anyone who works with electronics on a regular basis needs at least some minimum of test equipment to carry out measurements on electronic circuits or equipment. A multimeter forms the basis of this, but a scope and function generator are also required if a more in-depth investigation is called for. Using a PC and some free software you can have this functionality for low frequency measurements, without having to buy additional test equipment.



The PC is used more and more for all kinds of test and control applications. A lot of special hardware and software is available for this purpose. In addition, even with stand-alone test gear we see the trend that this equipment is frequently designed with a computer as a starting point for which then special I/O-hardware and dedicated software is developed. If you do not have the need for wide-band or high-frequency measurements, then

you can do remarkably well using your own computer and some handy software. In this way you will have an easy to read scope and a universal function generator for, at least, the audio frequency range.

We have described software for this purpose in Elektor before, but this time we have limited ourselves to freeware and software that you are allowed to use free for private and educational purposes (for

business or professional use you will have to pay for the software). So, you can actually measure for free — that computer was sitting there already!

### What do you need?

In reality, any modern computer is fast enough to carry out simple analogue measurements or generate audio signals. So, we need a PC running the Windows operating system as a platform. XP is the best option



for this, most of the programs including the older ones will run without problems on this. For other platforms such as Linux and Mac OS the availability of test and control software is unfortunately very limited. In addition a sound card is essential and the characteristics of this card are important, these determine the measurement capabilities. Fortunately, sound cards have improved much in recent years and even on a standard motherboard there is often an audio chip set which operates at 96 kHz. If you are going to buy a separate sound card for this purpose, you could, for example, choose a model with a maximum sampling frequency of 192 kHz and a resolution of 24 bits. These are available nowadays starting at about 100 pounds.

The input and outputs of a typical sound card are usually made with RCA sockets or 3.5-mm jacks. These are not really suitable if you want to use them for measuring purposes. So it is very convenient to make or buy a few adaptor cables to go from BNC to RCA or 3.5-mm jack. Now you can, for example, connect a standard oscilloscope probe to the input (note: only use a 1:1 type, don't use the type with a built-in 10:1 attenuator). The same is true for the outputs: you can make an adaptor to use the familiar BNC connectors, but an adaptor cable with a double banana socket can also come in very handy.

When using a sound card for measuring be careful to note the magnitude of the voltages that you will be measuring. Normally the line input cannot handle signals over  $\pm 0.5$  V, with larger voltages the A/D converter will be over-driven. So when measuring larger voltages an input attenuator needs to be connected in front of the input. Also keep in mind that the input impedance of such a sound card is not very high, often only a few k $\Omega$ . This is clearly less sensitive than a real scope and can potentially affect the circuit under test.

The microphone input can be used for very sensitive measurements. However, note that one of the microphone inputs has a DC voltage for powering an electret-microphone. When using the outputs we

have to keep in mind that we cannot load them too much, you cannot, for example, connect a load of 50  $\Omega$  directly to the output. In such cases you will need to connect a small power amplifier to the line outputs (use for example a little amplifier from an old active PC speaker, but just to be sure that it is appropriate, measure the frequency characteristic first, using one of the programs described below).

### Oscilloscopes/Audio Analysers

**Audio Analyser V1.9** [1] by Sebastian Dunst is a spectrum analyser for audio signals with a few additional features built-in, which are very convenient. With this free program you can carry out a real-time frequency analysis. Sampling frequency, FFT length and FFT window type are easily selected. You can average a number of measurements and you can place two markers, which will then continuously indicate the

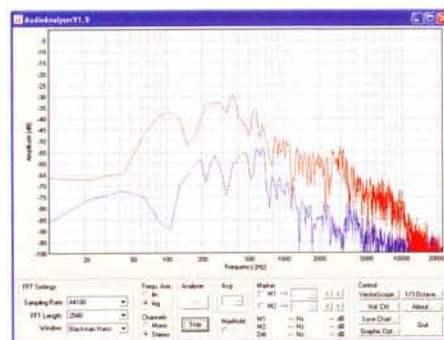

signal levels at a certain frequency. In addition there are several handy tools built in: a vector scope which will display the level and phase difference between the left and right channels and a 1/3-octave analyser. The measured data can be also saved to a file. The FFT analyser reacts fast, particularly on a modern computer with substantial computing power.

The **BIP Oscilloscope** [2] by Marcel Veldhuizen is a program that is now more than ten years old and perhaps does not offer quite all the features that some of the other programs described here do. But it still works under Windows XP, has a clear layout and is easy to operate via rotating knobs. When

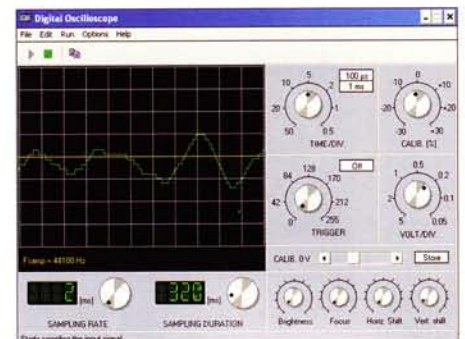

using this scope you do get the impression that under Windows XP it runs a little slower than the other programs and does not have the same detailed signal reproduction. This may of course have to do with the age of the software.

### Function generators

**Audio Sweepgen** [3] is a small, well-organised program that was specifically developed by David Taylor to produce audio-sweeps. You can select the signal wave shape for the sweep to be either a square wave or a sine wave. In addition there are buttons for a number of common sweep ranges, such a speech, for example. You can also select the exact start and stop frequencies manually. The sweep speed is also completely adjustable or you can select from a few pre-defined times. There are linear and



logarithmic options for the sweep and you can also turn on a half-octave marker.

The **BIP Sine Wave Generator** [4] is a simple sine wave generator where you use two rotary knobs to set the frequency and



amplitude. There is also a sweep option. The program is from the same era as the BIP scope (and is also by the same author) and appears a little dated. It still operates on many computers, but on our computer we nevertheless experienced strange output signals every now and then, which could be 'straightened out' by clicking the Mute button briefly.

The function generator called **Multisine V1.74** [5] is an excellent tool for producing all kinds of signal shapes using a sound card. As already suggested by the name, this software can generate signal shapes which consist of multiple sine waves, where you can choose the frequency, amplitude and phase of each individual sine wave. But all sorts of other wave shapes are possible, such as a normal sine, square, triangle and

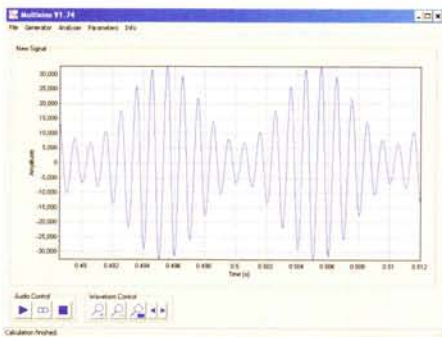

sawtooth. In addition you can also select a sweep between two frequencies, even an amplitude or frequency modulated signal can be built. The software can also generate white or pink noise. With the aid of the built-in frequency analyser you can look at the frequency composition of the generated signal. The shape of the output signal

is shown on a type of scope screen. A very versatile program!

**SigJenny** [6] is a generator program that on first impression does not appear to amount to much, but first impressions deceive. You can, of course, generate a sine, triangle or sawtooth. A very nice feature is that you can change the shape of the triangle smoothly towards a sawtooth. There is also a sweep

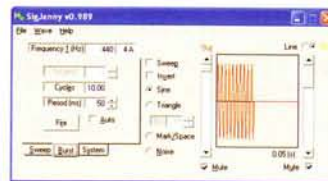

option, where you have the options between a linear or logarithmic sweep, the sweep can also run in both directions. In addition it is possible to generate a signal burst, where the burst-frequency, the number of periods that the burst lasts for and the repetition frequency are all adjustable. An example of the generated waveform is shown in a small window. The program finally also offers the option to measure the frequency characteristic of a speaker using a microphone, this is then shown in the window on the right. This is not very accurate, but nevertheless very handy for a quick check.

**Multi-purpose software**

These are programs which have multiple functions; these often form a complete basic lab with an oscilloscope and a function generator.

**Audio Test Bench** [7] is a collection of individual programs available for free from HigherFi.com, a large internet retailer for high-end audio equipment. The collection comprises, among others, a handy oscilloscope that was originally available as free-ware made by a Russian student years ago, but now a newer version, called Zelscope, can be bought for a modest amount. The collection also includes a spectrum analyser that originates from Dazyweb Labs, a simple tone generator where you can set the

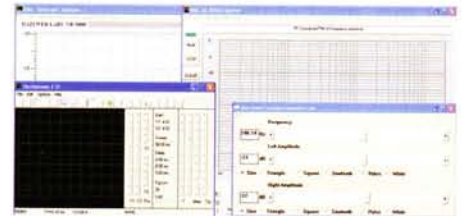

frequency, amplitude and different signal shapes and finally a frequency plotter that you can use to make a frequency characteristic, also from DazyWeb. These are all somewhat older software, but nevertheless a nice collection to keep at hand when you want to measure something.

The **Soundcard Scope** [8] is a nice measuring application which is realised entirely in Lab-View from NI. The program really looks like a normal scope, with buttons that you can turn with the mouse for setting the input sensitivity and time base. The program reacts quickly to changes in the input signal, you really do get the feeling that you are working with a real oscilloscope. All the usual scope functions are available and there are several trigger options. In addi-

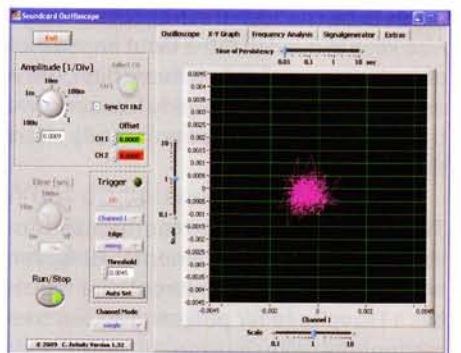
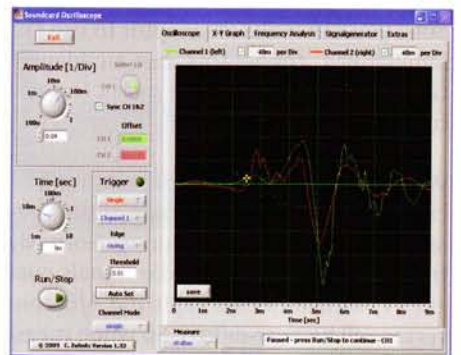

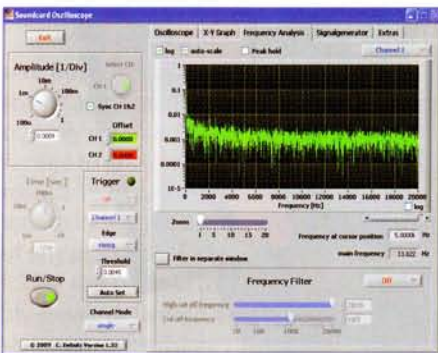
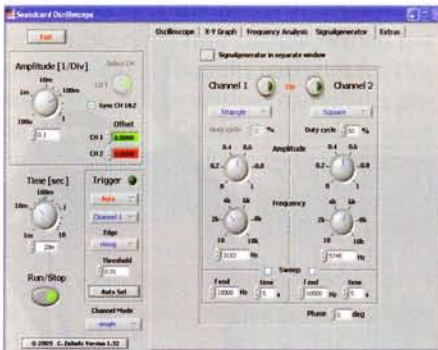

tion to a normal scope display you can also change, using a tabbed page, to X-Y display for Lissajous figures. Furthermore there is a tab which shows an FFT window, so that you can also do a Fourier analysis on the measured input signal. The next tab reveals a two-channel function generator, which can, for the most part, also be set using rotary buttons. For the signal shapes you have the choice of sine, triangle, square, sawtooth and white noise. A sweep between two frequencies is also possible. In the final tabbed page we find the settings for the sound card (such as sampling frequency) and a recorder where the measured signal can be stored as a .wav file. Very handy!

**Visual Analyzer** [9] is a program with Italian workmanship and has a remarkably large number of options. By default there appear two large windows on the screen; one functions as a two-channel oscilloscope and the other window simultaneously shows an FFT analysis of the measured signals. Both the scope and FFT analyser react very quickly and they are therefore very nice to work with. There are countless settings and as a

consequence it is sometimes hard to locate the desired option. In addition you can also display the phase characteristic in a separate window and you can also call up a window with a frequency counter. There is, of course, also a comprehensive signal generator which can generate various waveforms and also offers a sweep function. Other features are the option to calculate THD automatically

and to make LCR-measurements with the aid of some additional hardware (the schematic is available from the authors' website). Unfortunately the design is a little cluttered and the program does not always stick with the standard Windows conventions, but if you can live with that then this program offers a superb number of features.

(100175-1)

## Links & Literature

- [1] Audio Analyser:  
<http://softsolutions.sedutec.de/audio-analyser.php>
- [2] BIP Oscilloscope:  
[www.electronics-lab.com/downloads/pc/002/index.html](http://www.electronics-lab.com/downloads/pc/002/index.html)
- [3] Audio Sweepgen:  
[www.satsignal.eu/software/audio.html#SweepGen](http://www.satsignal.eu/software/audio.html#SweepGen)
- [4] BIP Sine Wave Generator:  
[www.electronics-lab.com/downloads/pc/005/index.html](http://www.electronics-lab.com/downloads/pc/005/index.html)
- [5] Multisine:  
<http://softsolutions.sedutec.de/multisine.php>
- [6] SigJenny V0.989:  
[www.natch.co.uk/downloads/SigJenny/SigJenny.html](http://www.natch.co.uk/downloads/SigJenny/SigJenny.html)
- [7] Audio Test Bench:  
[www.higherfi.com/software.htm](http://www.higherfi.com/software.htm)
- [8] Soundcard Scope:  
[www.zeitnitz.de/Christian/scope\\_en](http://www.zeitnitz.de/Christian/scope_en)
- [9] Visual Analyzer:  
[www.sillanumsoft.org/prod01.htm](http://www.sillanumsoft.org/prod01.htm)

# LiPo Auto Balancer

## Automatic balancing for LiPo battery packs

By Dr. Thomas Scherer (Germany)



Most people are aware of lithium rechargeable batteries: they are lightweight and can supply lots of power. They also have a bit of a reputation for being sensitive to abuse and have been known to burst into flames. Nevertheless LiPos are becoming the cell of choice for a growing range of mobile applications. What exactly are 2s, 3s and 4s battery packs and why do they need balancing anyway? Read on, we will shed some light on the subject.

As an ideal rechargeable battery LiPos tick more boxes than most other types of cell. They are light in weight, offer high energy density, low self discharge and have the ability to be recharged relatively quickly. On the downside these cells are rather intolerant to careless charging indeed the charging technique is almost a science in itself. Any consumer product boasting 'Lithium powered' is sure to come with its own dedicated charger with special charge and monitoring circuitry. This is designed to prevent the two destructive processes of LiPo batteries, namely deep-discharge and more seriously over-charging or cell short-circuit.

The last condition is particularly dangerous, lithium is highly reactive; if this does occur, better have a bucket of sand handy!

### LiPo cells

Lithium Polymer (LiPo) rechargeable batteries have in recent years been embraced by

borne electric model applications. Recent price falls have also made them more attractive. LiPos from recognised manufacturers such as Kokam or Ansmann retail at around £28 per 4000 mAh cell, in comparison cells from China are currently selling on eBay at around £5 per cell. A quick search of "lipo 5s" on eBay will give you a better idea of today's going rate.

A battery pack described as 5s has five cells connected in series. The battery's capacity (C) is given in mAh. A 4000 mAh battery stores enough energy

to supply 4 amps continuously for one hour. A 4 Ah battery with five cells is therefore described as LiPo 5s 4000. Another impor-

## adjustable balancing of 2s-5s Lithium batteries

the model building community. Their light weight and high discharge current capability make them an ideal power source for air-

tant property is the battery's maximum permissible discharge current. When the author originally bought batteries for this project the Chinese versions had inferior discharge rate of 15 C compared to 30 C from the recognised suppliers. The most recent offerings from China however maintain their low price but have a much improved spec, equivalent to the recognised brands. A battery rated as 30 C can safely discharge 30 times its hourly rate; in this case 120 A in two minutes.

Even with the 15 C rating of the cells used by the author (Figure 1), 60 A is quite impressive and more than sufficient for this application. These batteries were originally purchased from the Far East over a year ago to power a homebrew electric cycle project. To date they have been subject to more than 100 partial charging cycles without any problem. With a combined voltage of 37 V the two battery packs have probably never delivered any more than 10 A maximum. In hindsight the outlay of around £40 for these batteries has represented very good value.

### A tricky balancing act

Charging a LiPo cell is not especially difficult; just supply a constant current in the range of 0.5 to 1 C and wait until the cell voltage reaches 4.1 to 4.2 V. For a single cell this is quite straightforward but when several cells are wired in series to form a battery pack, slight variations in each of the cells properties create problems over time as the pack undergoes many discharge/charge cycles. These discrepancies will cause a cell to age prematurely and eventually die if no steps are taken to balance them out. This problem does not occur with NiCd or lead-acid batteries.

LiPo cells in a battery pack are not completely identical. Each has a slightly larger or smaller capacity than the next. Take a simple case with two cells wired in series, the one with the smaller capacity becomes fully charged before its partner, if charging continues until its partner is fully charged the lower capacity cell will receive a slight overcharge. During discharge the lower capacity cell runs out of charge first so its poten-



Figure 1. The power source for the author's electric bike. Two series-wired 5s LiPos from China built into a small aluminium case with a thermal fuse.

## Features

- Fully automatic balancing
- Two LED indicators per cell
- Voltage range 6 to 32 V (6 to 44 V using an LM348n)
- Selectable LiPo pack size from 2s to 5s using jumpers
- Lead-acid cells from 3s to 5s can be balanced
- Balance can be performed on two LiPo packs (up to 5s each)
- 200 mA balancing current (expandable)
- Balancing of cells with 2 Ah to 10 Ah capacity (expandable)
- 2.5 mA quiescent current with 5s and 1 mA with 2s packs

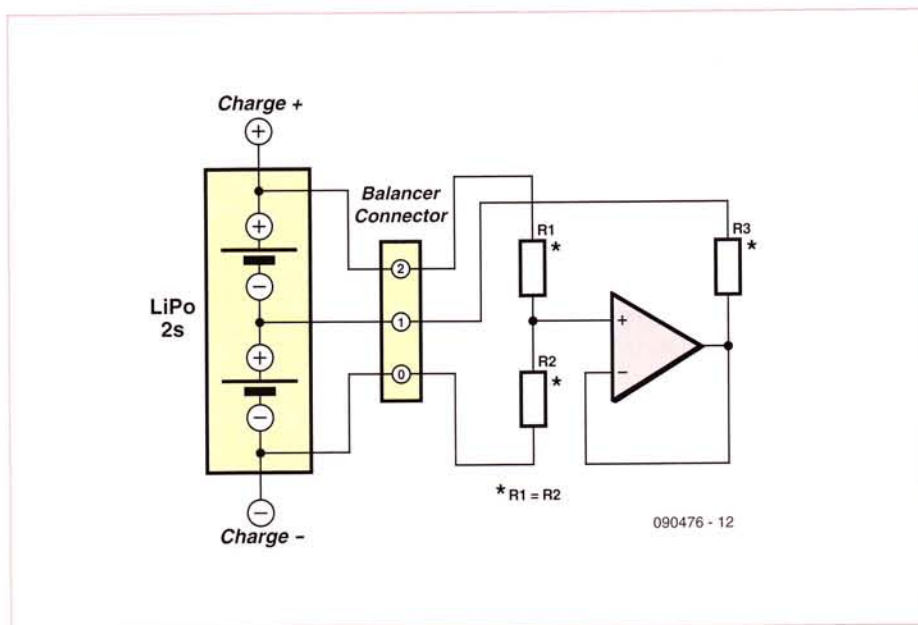

Figure 2. A power opamp and three resistors is all it takes to perfectly balance two cells.

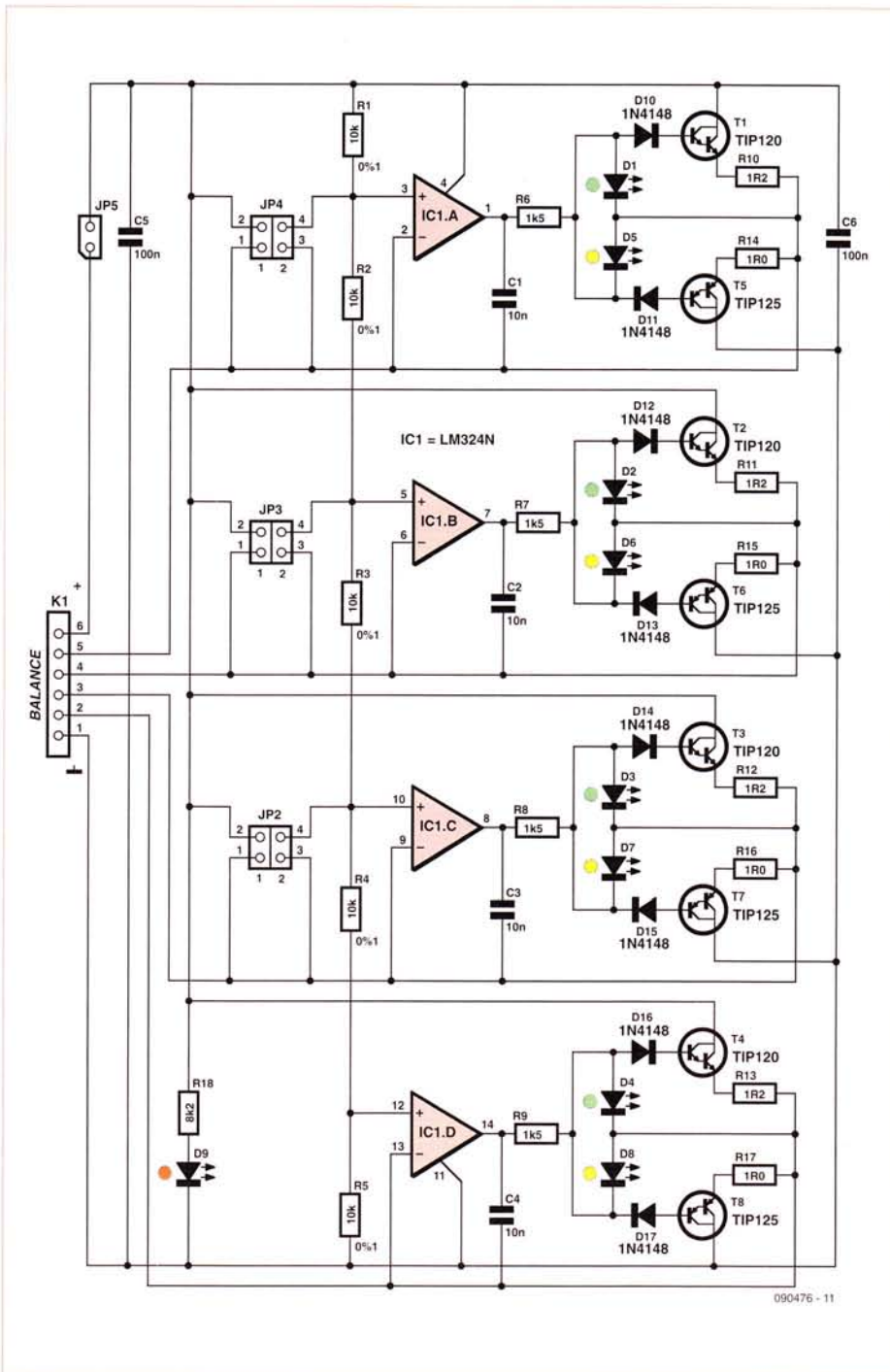

Figure 3. More cells = more opamps and more resistors. More current = Class B Darlington transistor output stage. More convenience = LEDs indicate current flow.

tial falls. In time and with more charge/discharge cycles the differences between the cells becomes magnified and the successive overcharging and deep discharging leads to damage to the lower capacity cell.

The solution to the problem in principle is fairly simple: cell potential is a good indicator of the amount of charge in the cell, we therefore only need to make certain that each cell in the pack has exactly the same voltage to ensure that it is balanced.

### Balancing methods

The brute force approach is (after every two charge cycles) to discharge each cell until its potential falls to a defined voltage level. All the cells will then be at the same voltage with any accumulated offsets reduced to zero. The disadvantage of this method is that the energy discharged during this procedure has simply been dissipated and lost. The cells must be charged again before use.

Laptop battery packs usually contain battery management hardware within the battery housing. Here a microcontroller monitors the voltage of each cell and diverts charging current around weaker cells to ensure that the entire pack achieves a full charge.

Even more complex are the chargers which can return surplus energy so that when the cells are being balanced as little energy as possible is wasted. From the point of view of energy conservation this solution is optimal but the additional hardware is quite complex.

We can surely do better than the crude first method and the more complex methods are really not universal enough. There is an alternative; a super-simple method

## How it works

Connect the balancing connector of the LiPo pack to connector K1 of the balancer. Jumpers JP2 to JP5 are used to set up the balancer for the number of cells (2 to 5) to be balanced. The Jumpers marked JPx-1 connect the battery voltage to the circuit while

Jumpers JPx-2 connect the battery to the voltage reference chain. Two jumpers are necessary for 2S to 4S packs, but 5S packs require just one jumper.

A fully charged five cell LiPo battery pack will have a voltage of up to 21 V (4.2 V/cell).

The voltage taps are produced by a chain of close tolerance resistors R1 to R5 connected across the battery voltage. Each opamp compares the actual cell voltage with the reference voltage tap. When the cell voltage is different from the tap voltage the opamp switches one of the Darlington transistors to either charge the cell (when its cell potential

## COMPONENTS LIST

### Resistors

R1–R5 = 10k $\Omega$  0.1%  
 R6–R9 = 1.5k $\Omega$   
 R10–R13 = 1.2 $\Omega$   
 R14–R17 = 1 $\Omega$   
 R18 = 8.2k $\Omega$

### Capacitors

C1–C4 = 10nF, lead pitch 5mm  
 C5, C6 = 100nF lead pitch 5mm

### Semiconductors

D1–D4 = LED, green, low current, 5mm  
 D5–D8 = LED, yellow, low current, 5mm  
 D9 = LED, red, low current, 5mm  
 D10–D17 = 1N4148  
 T1–T4 = TIP120  
 T5–T8 = TIP125  
 IC1 = LM324, LM348N (see text)

### Miscellaneous

K1 = 6-pin SIL pinheader, lead pitch 0.1 in. (2.54mm)  
 JP2-1–JP4-2 = 4-pin double row pinheader, lead pitch 0.1 in. (2.54mm)  
 JP5 = 2-pin pinheader, lead pitch 0.1 in. (2.54mm)  
 14-way IC socket for IC1  
 10 pcs heatsink isolation set for TO220 style transistor  
 Aluminium bracket or heatsink  
 PCB # 090476

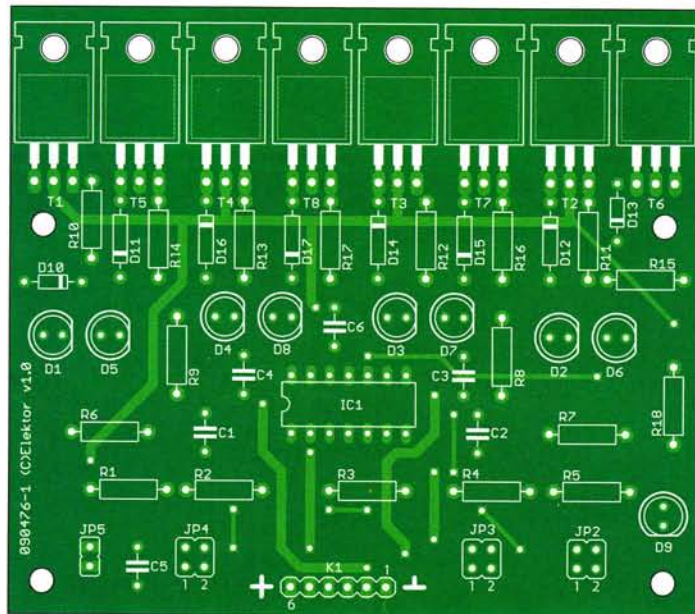

Figure 4. The components are well spread out, making construction a simple task.

which performs the delicate balancing act automatically with relatively low energy losses...

### An auto balancer

The operating principle of this method using two cells is shown in **Figure 2**. A potential divider formed by R1 and R2 produces a voltage at its centre point of exactly half the combined voltages of the upper and lower cell.

The (power) opamp drives current via the current limit resistor R3 to the centre connection of the two batteries. When the upper cell has a higher voltage than the lower cell, current flows into the lower cell until both are

at exactly the same potential and balance is achieved. No set-up or calculations are necessary except to fix the value of R3 to give a balancing current somewhere in the region from 0.02 to 0.1 C.

## Fully automatic balancing

What if you have more than two cells? Simple, just add more opamps. A quad opamp will be sufficient to balance packs with up to five cells. Standard opamps cannot handle the required balancing current so a class B

transistor stage is added to boost current. Low-priced power Darlington (T1 to T8) are a good choice to help keep costs down. **Figure 3** shows the complete circuit diagram of the balancer in regular use by the author. It can balance two to five cell battery packs. The forward voltage drop across each LED limits the transistor base voltage. Together with the emitter resistor this gives an output current limit of approximately 200 to 250 mA. This is suitable for cells with a capacity in the range of 2 to 10 Ah. With the addition of extra heat-sinking the balancing current can be increased by using lower value resistors R10 to R17. The unit will then

is too low) or discharge it (when the cell potential is too high). The result is that all the cells attain the same voltage level.

As long as the balancing current is >20 mA the corresponding LED will light up. The output stage can pass a maximum balancing

current of 250 mA. Output current limiting can be described by looking at the configuration around IC1A for example. Depending on the state of charge D1 or D5 will be lit by current through R6. The voltage across the conducting LED will be around 1.8 V. Subtracting the forward conduction voltage of the diode (D10 or D11) and the base emitter

drop of the Darlington (about 1.0 to 1.1 V) leaves 0.2 to 0.3 V drop across the 1  $\Omega$  emitter resistor which effectively limits the current to around 250 mA.

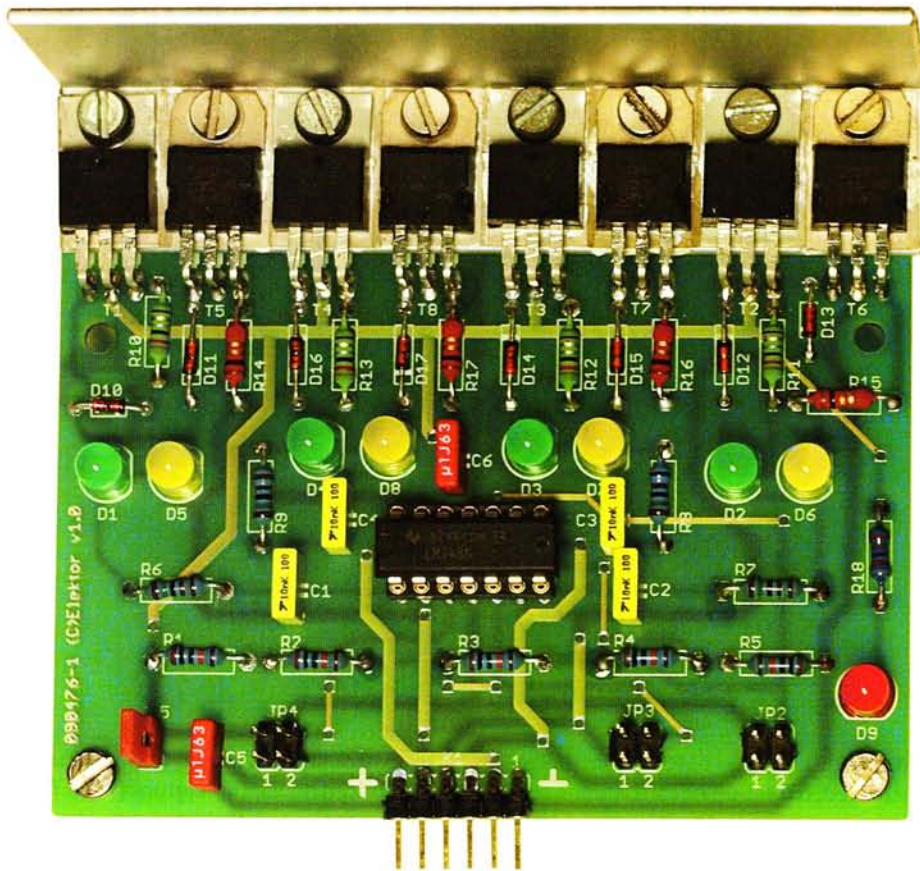

Figure 5. The completed PCB. A length of aluminium angle provides sufficient heat sinking for balancing the 4 Ah cells.

achieve balance more quickly shown by the LED indicators. The heat sink only requires a limited thermal capacity. The use of jumpers allows the unit to be configured to balance packs from 2S up to 5S.

**Construction and test**

The finished PCB (Figure 4) shows that the components are well spaced out on the board and no SMD packages are used. Construction should therefore be fairly easy even for those who admit to being a little ham-fisted. As can be seen from Figure 5 a length of aluminium right-angle profile is fitted on the board to act as a heat sink for the output transistors and in most cases this will suffice. The transistors can also be mounted standing up at right-angles to the PCB giv-

ing space for a larger heat-sink. Mounting holes for such a heat sink are provided on the PCB.

It is important to ensure that the transistors are electrically isolated from the heat sink by using mica (or similar) insulators together with insulating bushes on the mounting bolts. A small amount of heat-sink compound under the transistors assists heat transfer. Once construction is complete a continuity tester can be used to check that all 10 transistors are insulated from one another.

After the insulation test and a final visual check of the component placement fit a single jumper to JP5 (5s) leaving all the other jumper positions free. Adjust the output

voltage of a bench power supply to approximately 10 V and connect it to the two outermost pins of connector K1 (observing correct polarity). LED D9 should now light and just a few milliamps will be drawn from the supply. If everything is in order increase the supply to 20 V. D9 should now burn more brightly and using a multimeter you can check that voltage levels on pins 2, 3, 4 and 5 of K1 are 4, 8, 12 and 16 V respectively (i.e. fifths of the total supply voltage). Using a bench supply with current limit capability set the maximum current to 0.5 A and short together any two adjacent pins on K1. A maximum balancing current of approximately 200 mA now flows from the supply.

Once the circuit has been tested it can be connected to the battery pack balancing connector. Don't forget to fit the correct jumper corresponding to the battery pack: for a 3S pack for example make sure that jumpers are only fitted to positions JP3-1 and JP3-2. The auto balancer should be left connected to the battery until all the LEDs (except D9) have gone out.

It is not strictly necessary to balance the LiPo pack at every charge. The author's routine is to balance them after every tenth charge cycle. His installation consists of two 5S packs connected in series so first each pack is individually balanced. The balancer can now be jumpered into 2S balancing mode and the dual battery pack reconnected with its positive lead connected to pin 3 on K1, the negative lead to pin 1 and the battery series connection to pin 2. This final balancing stage can only be completed if an LM348 is fitted in position IC1 in the circuit, this IC is rated up to 44 V. The alternative LM324 is suitable for voltages up to 32 V maximum which is sufficient for 2 x 4s (and of course 1 x 5s).

(090476)

**Literature**

- 'Super Lithium Batteries', Elektor April 2005, [www.elektor.com/040168](http://www.elektor.com/040168)





# electronica

focus on the future<sup>e</sup>.

get the whole picture

24th International Trade Fair  
New Munich Trade Fair Centre  
09–12 November 2010  
[www.electronica.de/en](http://www.electronica.de/en)



**electronica** 2010  
components | systems | applications

# InterSceptre opens doors (and ports!) for you

## Microcontroller Extension Board

By Clemens Valens (Elektor France)

A few months ago, we introduced Sceptre, a fast prototyping system fitted with a 32-bit microcontroller. Even on its own, this little board will let you produce some great results, but if we add an extension board to make it easier to access all its peripherals, the Sceptre platform becomes downright powerful. What's more, if you fit this extension board into a suitable case, you'll be able right from the start to develop a prototype that you can use 'properly' in a installation, with no trailing wires or bits of sticky tape holding everything together. Now that's what you call fast, convenient prototyping!

So there we have the broad specifications for InterSceptre, the Sceptre [1] extension board with multiple interfaces. And even though the development of InterSceptre was inspired by the Sceptre, the board can be used with any other microcontroller, provided it is fitted to a board that'll fit into the space reserved for the Sceptre. InterSceptre operates from 3.3 V and 5 V, so it's perfectly suited to PICs, AVRs, and other popular micros.

So what has InterSceptre got to offer? Well, quite a lot, actually (Figure 1): two RS-232 ports, two RS-485 ports (or one RS-422 port), a DMX512 port, a MIDI input/output, an I<sup>2</sup>C port, an SPI (or PS/2) port, space for a WIZnet Internet module, four analogue outputs (DAC), analogue inputs (ADC), digital I/Os (logic, PWM), four LEDs, a JTAG connector, a holder for a button cell, a small prototyping space, extension connectors, and a 5 V power supply. All this on a PCB that fits exactly into an attractive, Italian-designed case measuring 18 × 20 × 5.4 cm.

Before you rush off to the Elektor online shop to order this extraordinary board, do just be aware that you can't use all of these facilities at the same time. Even though the Sceptre offers lots of peripherals, it only has fifty pins, which means that certain functions are obliged to share pins. Nevertheless, we've done everything we can to make

InterSceptre as flexible as possible. In any case, there are very few applications that would require everything to be used at once.

### Detailed description

Let's take a look at the InterSceptre extension board circuit diagram. Given the number of ports implemented, the circuit is pretty huge, but easy enough to follow (Figure 2).

### RS-232, RS-485 & RS-422

The RS-232 and RS-485 ports share two 9-way sub-D connectors. We opted for male connectors to ensure compatibility with PC serial ports. On the microcontroller side, the four ports are connected to terminal strips that let you choose which will be used with a given COM port. The Sceptre has only two UARTs, one of which is more or less reserved for the Bluetooth module (although the latter can be disconnected), but it's always possible to produce UARTs in software (bit banging). For microcontrollers with more UARTs, the ports are available to them.

Two DIP switches let you economize the output select pin for applications that only transmit in RS-485. Two other switches offer the possibility of connecting terminating resistors if needed.

---

works with all microcontrollers

---



## Technical specifications

- Compatible with all types of microcontroller
- Internet
  - 2 × RS-232, 2 × RS-485
  - DMX512 compatible
  - MIDI
- 4 analogue outputs
- I<sup>2</sup>C, SPI, PS/2
- Digital I/Os (logic, PWM)
- JTAG for Sceptre
- Operates on 3.3 V and 5 V

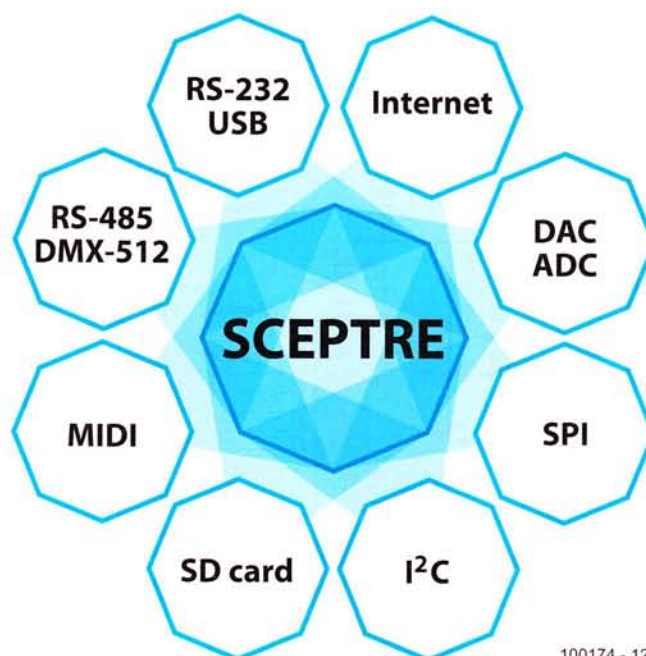

100174 - 12

Figure 1. InterSceptre block diagram.

The Sceptre's USB connector is shared by a serial port and the USB port. We've taken advantage of the InterSceptre to add a special USB connector for the Sceptre's USB serial port. What's more, this is the InterSceptre's only surface-mount component.

### DMX512

One of the two RS-485 ports is also wired to an XLR connector for DMX512 applications. The DMX512 standard specifies a 5-pin female connector for a DMX transmitter, but many applications use 3-pin XLR cables. The InterSceptre PCB lets you fit either, so as to keep everyone happy.

### Musical Instrument Digital Interface (MIDI)

The MIDI port consists of just an input and an output. To save a bit of space on the PCB, we haven't made provision for a MIDI THRU port. Given that InterSceptre can operate from 3.3 V and 5 V, two DIP switches are provided to allow the MIDI standard's 5 mA output current to be maintained in either case. Not to worry even if the switches have been set to the 3.3 V position with the board running on 5 V — in this instance, the output current is only around 10 mA, which is more than acceptable for the majority of opto-isolators, even (or perhaps especially?) older ones.

The MIDI port shares the same microcontroller ports as the RS-232 and RS-485 ports.

### SPI, PS/2 and Internet

For experiments with an SPI port, InterSceptre offers a 6-pin mini-DIN connector. This connector is wired to be compatible with the PS/2 port, allowing you to connect a keyboard or mouse, or even both. Note that it is highly inadvisable to hot connect or disconnect equipment to this port.

The SPI port is shared by the WIZnet WIZ812MJ Internet module. This module, which implements a hardware TCP/IP stack, was described in [2] and offers several microcontroller interfaces, including the SPI we're using here (as the Sceptre doesn't have a parallel port).

The Internet module is powered from 3.3 V, but accepts signals up to 5 V. The output signal (MISO and INT) levels may then be too low for a microcontroller powered at 5 V. This is why we've added two simple voltage boosters. These may adversely affect the maximum communication speed possible, so if the whole circuit can run off 3.3 V, it's undoubtedly preferable to not fit them and to bridge out transistors Q1 and Q2.

Note to that InterSceptre does not offer a 3.3 V supply, as this is already available on the Sceptre. So a microcontroller running on 5 V will also need to provide the 3.3 V rail if it is intended to use the Internet module.

### DAC and MUX

The Sceptre has a 10-bit digital/analogue converter (DAC). To make it a bit more powerful, we've added a 4-channel analogue demulti-

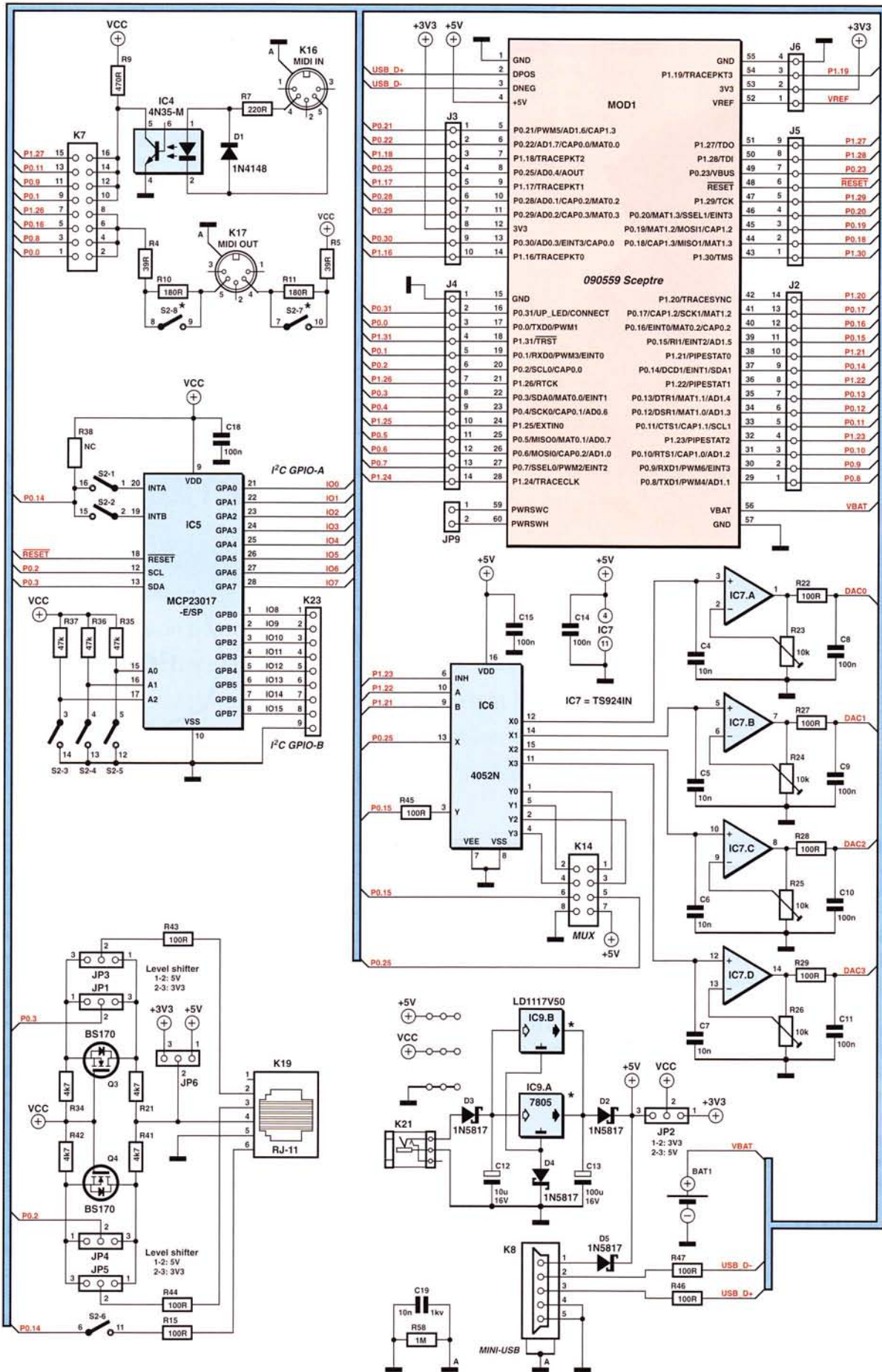
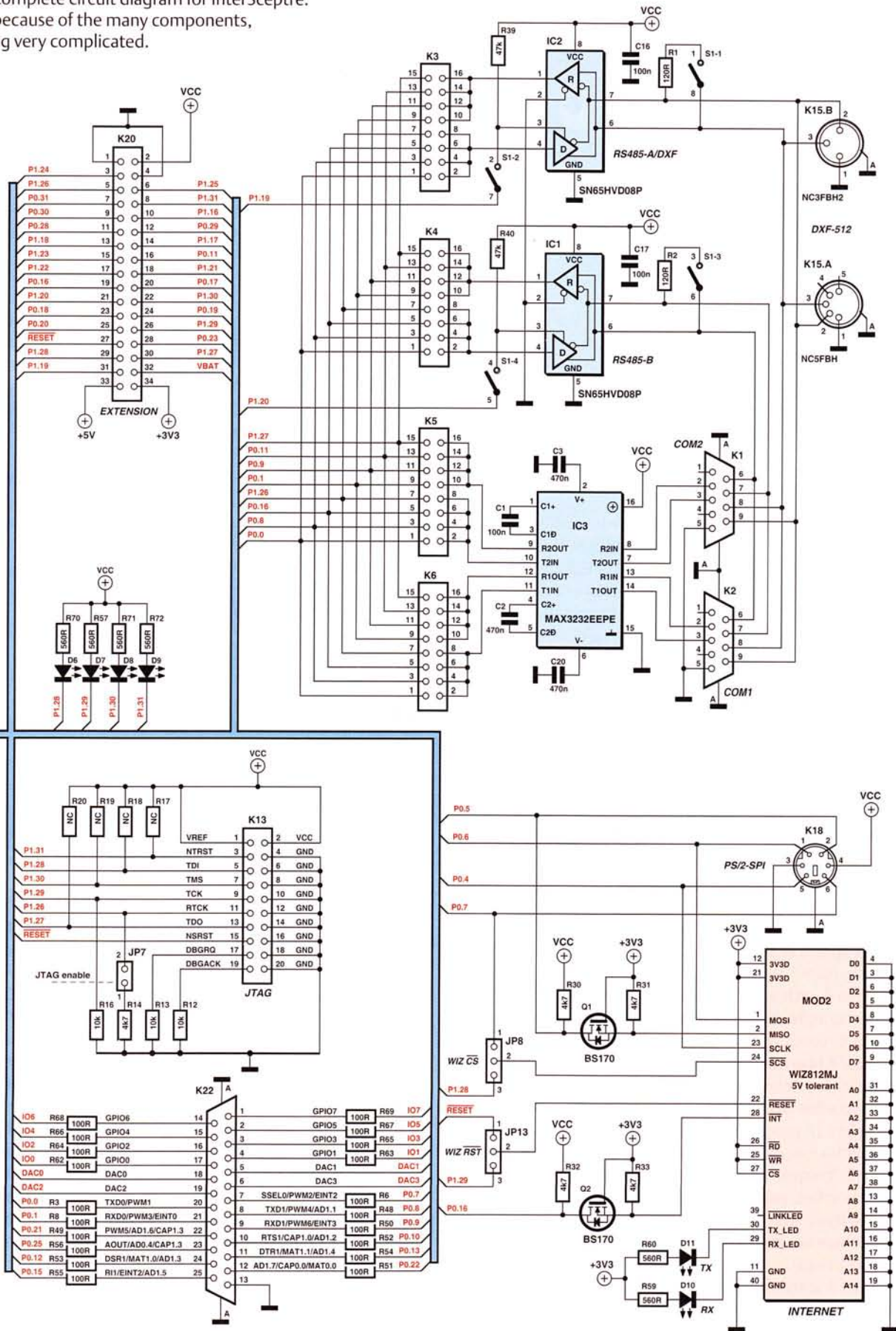

Figure 2. Complete circuit diagram for InterSceptre. A bit big, because of the many components, but nothing very complicated.



100174 - 11

plexer. In this way, InterSceptre has four analogue outputs, available on the 25-way sub-D connector K22.

The gain of the output stages is adjustable (a bit too much, really, for reasons of simplicity) and they are powered from 5 V, at all times, which means a 3.3 V system can produce (nearly) 5 V analogue signals. The gain is adjusted using 25-turn presets. If unity gain is all you need, you can omit these and connect the inverting inputs directly to the outputs. This will save you a bit of money.

The (de)multiplexer IC6 in fact contains two multiplexers so, as we don't like wasting precious resources, the unused multiplexer is accessible on an 8-way terminal strip, which lets you connect this multiplexer to the DAC output or one of the Sceptre's analogue inputs — or both.

#### I<sup>2</sup>C and GPIO

The Sceptre has two I<sup>2</sup>C ports, one of which is readily accessible without disturbing the other functions too much. This is the port we've connected to a 6-pin RJ11 connector via a voltage booster. In this way, it is possible to connect a 3.3 V I<sup>2</sup>C peripheral (for example a Nunchuck controller for the Nintendo Wii games console) to an InterSceptre running at 5 V (or 3.3 V); it also works the other way round. The very handy **Pocket terminal** that goes with the running-in bench described in [3] runs on 5 V, so it can be used with the Sceptre running on 3.3 V. The Pocket terminal offers an LCD display, five push-buttons, and a rotary encoder, driven via I<sup>2</sup>C.

The voltage booster used comes from a Philips (or NXP) application note [4]. It's both simple and ingenious, as it's bidirectional. For example, let's take the SDA signal (P0.3) and assume that the power rail is 3.3 V while the output voltage is 5 V (so all the jumpers are in positions 1 and 2). If SDA (in output mode) on the source of FET Q3 is at 0 V, Q3 conducts and hence the output (drain) is also at 0 V. If SDA is at 3.3 V, Q3 is turned off and the output is at 5 V thanks to pull-up resistor R21.

The other way round, when SDA is in input mode, it's a bit more ingenious. If the drain is at 0 V, the spurious diode in Q3 conducts and takes Q3 source, and hence SDA, towards 0 V. This causes  $V_{gs}$  to rise, the FET starts to conduct, and SDA goes to 0 V. If the drain is at 5 V, pull-up resistor R34 ensures that the SDA input sees a level of 3.3 V. The I<sup>2</sup>C port is also connected to a Microchip port expansion IC. This IC is compatible with 3.3 V and 5 V, so no voltage boosters are needed. It offers 16 programmable I/Os with interrupts and lots of other possibilities too. As it's an I<sup>2</sup>C port device (it is also available in an SPI version), it requires a programmable address. This is obtained using three switches, even though an I<sup>2</sup>C address consists of seven bits. The chip itself adds the missing four MSBs, hence its address is 0010xxx, where xxx represents the position of the three switches (0x20 to 0x27 in hex).

The chip's port A is accessible on the 25-way sub-D connector; port B is connected to 9-way terminal strip K23.

#### JTAG, LEDs, and other connectors

The JTAG connector is wired to the standard defined by and for ARM,

i.e. 20 contacts with (optional) pull-up resistors. To put the Sceptre into JTAG mode, jumper JP7 must be set and the board rebooted. Four LEDs (to be fitted at 90° underneath the Sceptre, otherwise they can't be seen) share a number of the JTAG port's signals. If this causes difficulties with JTAG communication, don't be afraid to remove them.

25-way sub-D connector K22 gives access to a selection of the microcontroller's various ports. So we find the PWM outputs, certain analogue inputs, the analogue outputs, a number of interrupts, and some basic I/Os. Each of the signals is protected by a small current-limiting resistor. This protection is rudimentary, so be careful all the same, and don't hot (dis)connect equipment.

The 34-way extension terminal strip K20 gives access to the microcontroller's other signals. Here, there's no protection at all, so you need to take great care. This terminal strip is opposite a little area with mounting holes where you can fit a few components to create an interface you need. A row of holes each side of the microcontroller board gives you direct access to all the processor's signals.

#### Power supply and battery

During application development, the Sceptre will be connected to a computer via a USB cable connected either directly to the Sceptre, or via the InterSceptre. In this situation, the USB port can provide all

the power. For applications where no USB connection is possible or necessary, or if more power is needed than can be supplied by a USB port, a 5 V supply is avail-

able via the InterSceptre. We have made provision for two possible regulator types (a 7805 or a low-voltage-drop 1117-style), which, for some unknown reason, do not have the same pin-outs. So take care how you fit the regulator!

The on-board supply takes priority over the 5 V from the USB ports by way of diode D4, making the regulator output voltage around 0.3 V higher than the USB port voltage. The other diodes (D2, D5, and the other D2 in the Sceptre) take care of the rest. One important detail not to be overlooked: when fed from a USB port, the InterSceptre's 5 V rail isn't in fact quite 5 V, but more like 4.7 V. When self-powered, however, the 5 V rail really is 5 V.

The InterSceptre operating voltage  $V_{cc}$  is selected by means of JP2. As already mentioned above, the InterSceptre itself does not produce the 3.3 V, it comes from the Sceptre. If you are not using a Sceptre, you'll have to make provision for a 3.3 V rail if you need one.

One minor drawback with the Sceptre is the absence of the battery voltage on the extension connectors — but it does have its own battery. If you use a different microcontroller board without its own battery, a button cell holder is available on the InterSceptre. Attention! If you connect the Sceptre battery to the InterSceptre, don't fit a battery in the BAT1 holder as well!

You can connect a switch to JP9 to let you turn off the Sceptre power. This can be handy where the Sceptre is being powered from a battery. Don't forget to link the Sceptre switch contacts to the InterSceptre ones, which are just underneath.

## open-source and hardware

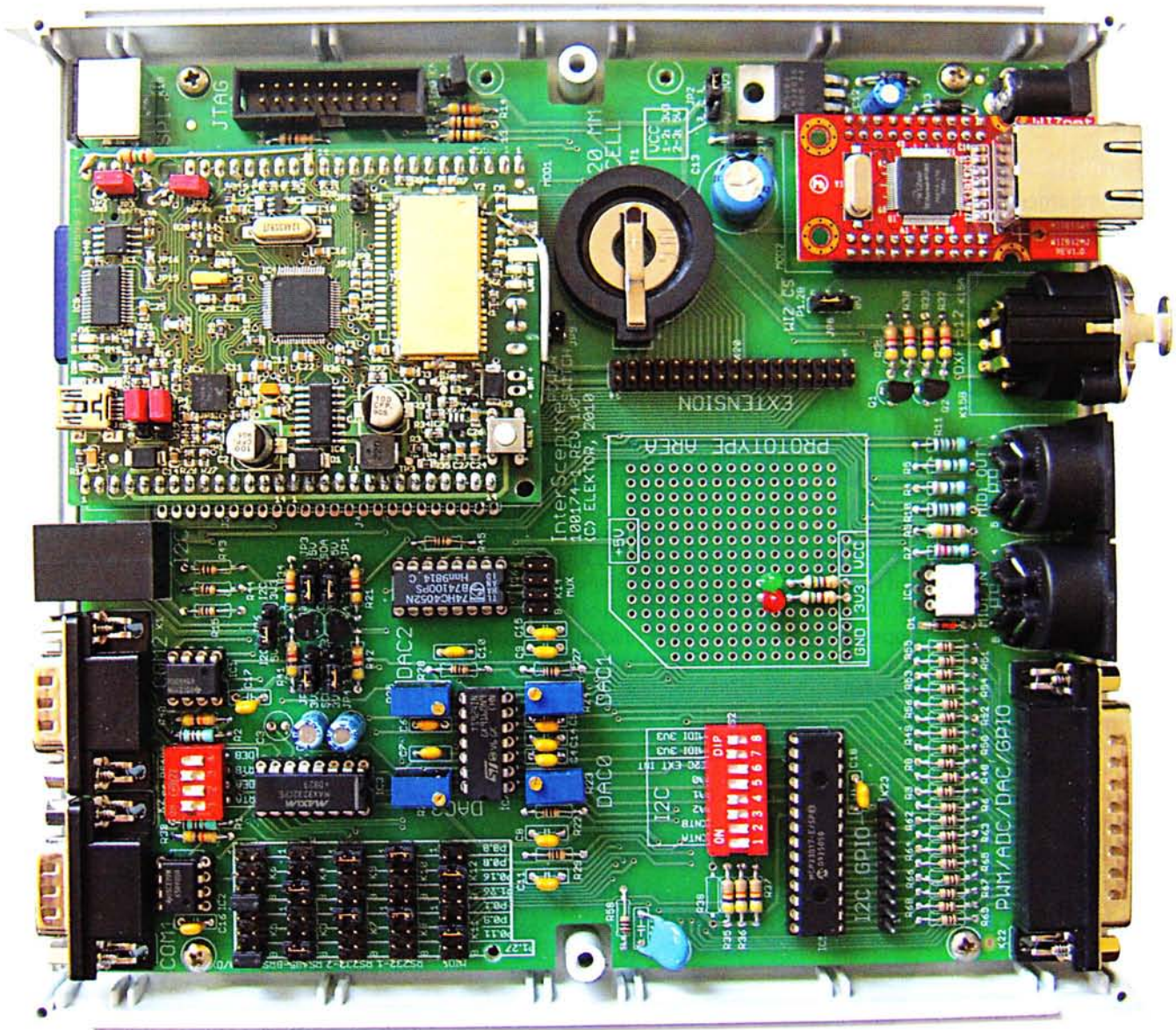

Figure 3. Combination of Sceptre + InterSceptre + WIZ812MJ.

### And finally...

InterSceptre uses only non-SMD components (except for the USB connector) and so is easy to wire up. No need to fit the parts you don't need — particularly the connectors, which can be quite expensive.

The InterSceptre PCB has been designed to fit into a case which, in addition to providing protection, also lets you use the unit directly within a final application without its looking like a bodge.

The case we've chosen is a Teko 935.5 (white) or 935.9 (black), which comprises two plastic shells (handy for the Sceptre's Bluetooth) and two aluminium front panels held in place by the shells. The shells fix together using a pair of screws. The example in our prototype was kindly provided to us free of charge by Okatron [6], the French distributor for Teko.

Like the Sceptre, InterSceptre is also an open-source, open hardware project. So on [7] you can find the Eagle files for the circuit diagram

and PCB, the components list, and a few bits of software for testing and using InterSceptre.

(100174-I)

### Internet links

- [1] [www.elektor.com/090559](http://www.elektor.com/090559)
- [2] [www.elektor.com/090607](http://www.elektor.com/090607)
- [3] [www.elektor.com/080253](http://www.elektor.com/080253)
- [4] [ics.nxp.com/support/documents/interface/pdf/an97055.pdf](http://ics.nxp.com/support/documents/interface/pdf/an97055.pdf)
- [5] [www.teko.it/en/prodotti/famiglia/FP/serie/30](http://www.teko.it/en/prodotti/famiglia/FP/serie/30)
- [6] [www.okatron.fr](http://www.okatron.fr)
- [7] [www.elektor.com/100174](http://www.elektor.com/100174)

# Starry Night

## Take some LEDs and an MSP430

By Lars Lotzenburger (Texas Instruments Germany)

Armed with a handful of LEDs a few driver chips and a microcontroller you can recreate a little bit of the Cosmos to hang on your wall at home. This unique celestial slide show displays the major constellations and is sure to be a talking point. The software can be easily altered to cater for system expansion.

The author built this originally to hang in his niece's bedroom. It gives a pleasant background glow and gently cycles through depictions of some of the major constellations. Using 32 LEDs the controller shows up to eight different constellations and is pre-programmed with the Big Dipper, Orion, the Dolphin, the Swan and Cassiopeia all of which can be seen from the northern hemisphere (see picture). Other constellations can also be programmed. The LEDs are fitted into a display panel, and in order to keep it to a manageable size the constellations are shown one after the other using some of the same LEDs to represent different stars in different constellations. A microcontroller adjusts the brightness of the LEDs to present a sort of celestial slide show with all LEDs reverting to a background level of brightness before the next constellation is highlighted. Any LEDs not used for a particular constellation are shown as dim 'background' stars.

### The Hardware

The design is flexible and the hardware described here can drive up to 48 LEDs so that many other constellations can be implemented. The software in its present build supports the depiction of up to eight different constellations. The LEDs are fixed in holes drilled in the chip board (or MDF) panel. For more details see 'Construction'.

The author has developed a simple low-cost electronic circuit; a microcontroller controls the brightness of individual LEDs connected to a multi-channel LED driver (the TLC5943 from Texas Instruments). The MSP430F2012 microcontroller was chosen for this job; it

is one of the smallest members of the well known MSP430 family.

### LED drivers

The LEDs are driven by three TLC5943 [1] 16 channel LED driver chips as shown in the circuit in **Figure 1**. Each output pin provides a constant current sink function so this means that all the LEDs must be wired with their

gives a maximum of 30 mA per LED (values up to 50 mA can be defined).

Each channel has a 16-bit wide grayscale register which allows 65536 levels of brightness to be set for each LED individually (this fine resolution is useful to give smooth transitions because the eye is particularly good at detecting slight changes of brightness).

The 'local' brightness of each LED is controlled by a Pulse Width Modulated (PWM) output signal which is generated in the driver chip using the grayscale input clock GSCLK supplied by the microcontroller. The internal logic generates individual PWM signals for each LED with an on/off ratio defined by the value stored in the corresponding grayscale register. One PWM period consists of 65536 GSCLK periods and the number of GSCLK periods that the LED is on during this time corresponds to the value in the grayscale register. The simplest way to implement the PWM waveform to control the LEDs would be to switch all LEDs on at the same time

and then counting GSCLK periods turn each one off at a time when the count equals the value in the LED's grayscale register. The on/off switching rate must however be greater than approximately 70 Hz otherwise a flicker is noticeable. Using this simple method would require a GSCLK of around 5 MHz to avoid flickering.

A better technique employed by the TLC5943 is to divide the complete PWM period into 128 equal periods (each period consisting of 512 GSCLK periods). The on period for each LED is then 'spread' over the 128 peri-

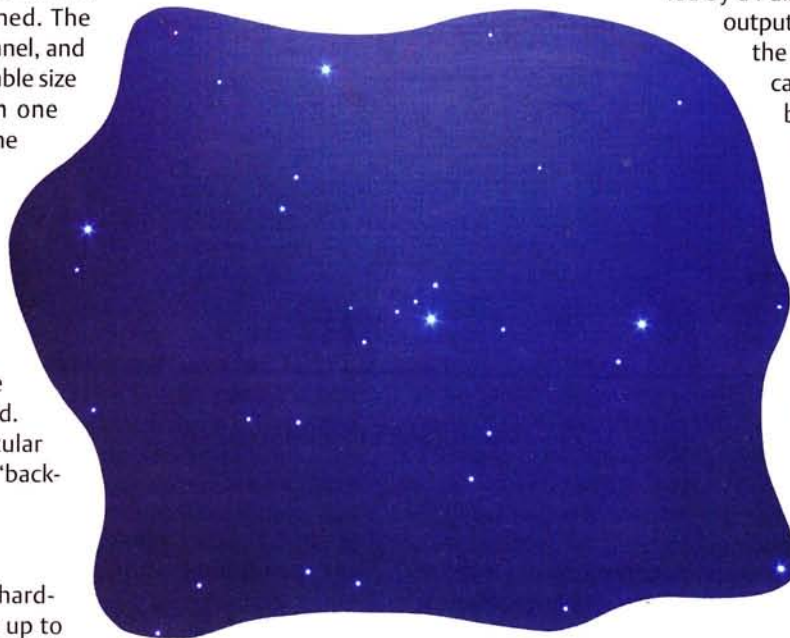

odes connected to the positive supply and their cathodes connected to output pins of the TLC5943s.

A global maximum current for each of the 16 LEDs is set by a single reference resistor connected to the IREF pin. This maximum value is divided into 128 steps by a 7-bit internal brightness control register (see block diagram in **Figure 2**). A value of 127 corresponds to the maximum current defined by the resistor connected to IREF. The resistance value used in this application



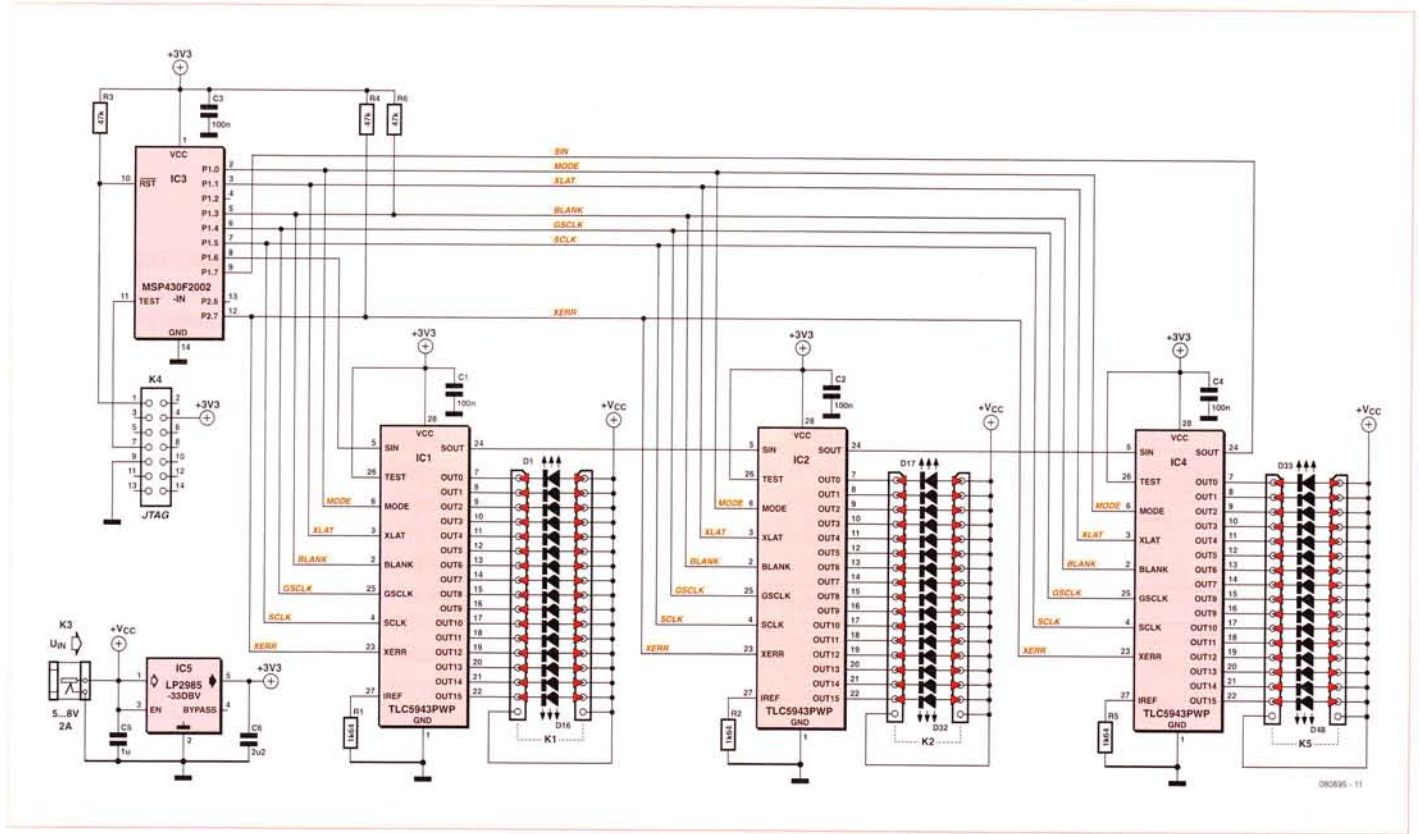

Figure 1. The three LED driver chips are daisy chained. The data paths are linked in series while control signals are paralleled.

ods (see Figure 3). This effectively increases the LED switching frequency and is known as 'Enhanced Spectrum PWM' (esPWM).

### Communication

The Grayscale LED values and the global brightness control value are sent to the LED driver chip over a serial interface which uses pins SIN, SOUT and SCLK. The voltage level on the MODE pin 6 (or BCSEL on the data sheet) determines if the serial data is either grayscale data (MODE=low) or global brightness control data (MODE=High). A rising edge on the XLAT pin transfers the serial data (grayscale or brightness) into intermediate latches. The microcontroller software also makes use of the BLANK pin by pulling it high to turn off all the LEDs.

An important feature of the TLC5943 is the possibility to expand the system by connecting additional TLC5943s in a daisy chain configuration. The SOUT signal from the first chip in the chain is connected to the SIN of next chip. Other signals such as the clock and control signals are connected in parallel with the corresponding clock and control pins of the other chips in the chain. To send a data word or byte to a particular driver chip it is inserted in the correct position in the serial data stream along with data for

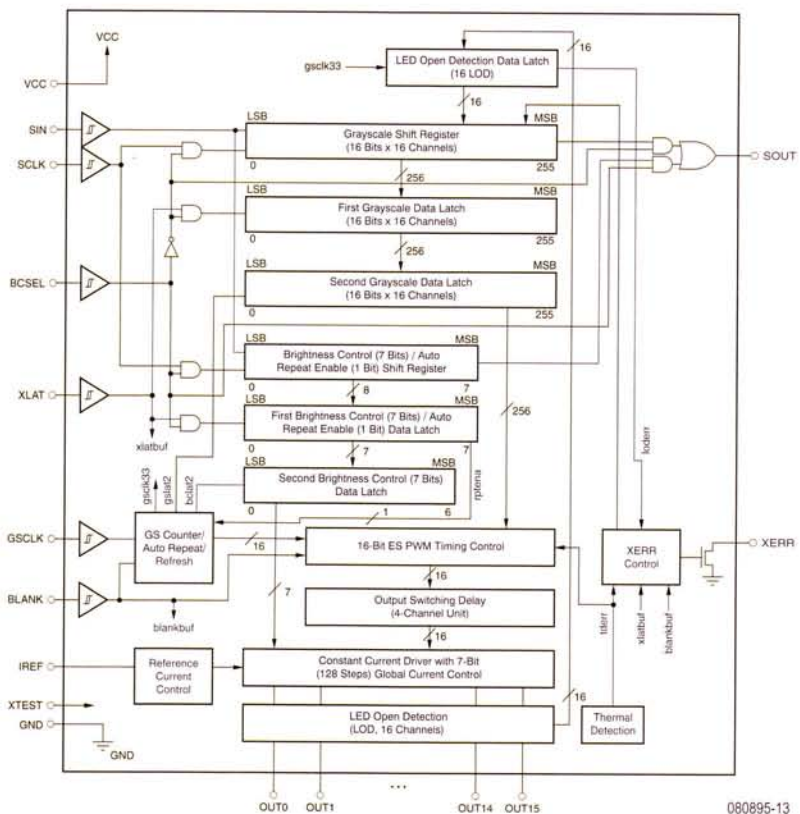

Figure 2. Block diagram of the LED driver. Maximum LED current is defined by an external reference resistor. A 7-bit brightness control register can further reduce LED brightness.

# Software Modding

The software can be adapted to meet your requirements. Changing the following #defines in the source code will alter the program's behaviour:

#define	Default	Description
IDLE_TIME	2	The period in seconds when no constellation is depicted (All stars are background)
FADEIN_TIME	5	The constellation fade-in time
SIGN_TIME	3	The period in seconds when the constellation is displayed at maximum brightness
FADEOUT_TIME	5	The constellation fade-out time (must be the same as FADEIN_TIME)
BRIGHT_BACKGROUND	250	Background brightness of the LEDs (No constellation displayed)
BRIGHT_SIGN	10000	Maximum brightness of the constellation LEDs (1 to 65535)
TLC5943_CNT	3	The number of TLC5943 chips in the system

And finally each LED must be assigned to one or more constellation(s). The LEDs are numbered from 0 to NUM\_LEDS - 1 (16 x TLC5943\_CNT - 1).

Where the LED number is assigned from:  $NumLED = NumTLC5943 \times 16 + NumPin$

NumTLC5943 is the number of driver chips where 0 represents the last in the chain from the controller's viewpoint.

The LEDsInSigns[ ] field indicates which constellation the LED is used in. The field contains as many unsigned char elements, as there are LEDs. Now a bit position is assigned to each constellation (according to 1, 2, 4, 8, 16 to 128). When a LED is used in one or more constellations, the respective bits are set in the associated field elements.

The Signs[ ] field defines how often and in what sequence the constellations are displayed. When the last constellation display is finished the controller goes into sleep mode until the next reset.

the other drivers and clocked through until it is latched into the driver's registers. Additional LEDs can be wired in series at the

output pins to produce more light. Additional information can be found in the data sheet [1].

## Controller and power supply

The LED drivers were discussed in some detail but the microcontroller need only be a general purpose device. Its most important task is to implement a bidirectional serial communication interface (SPI). It needs both a timer and the capability to generate a sufficiently high frequency GSKL signal required by the TLC5943. In the interests of economy the controller should be as small as possible with the least number of unused pins. The MSP430F2012 from Texas Instruments fits the bill admirably; it has a 2 kB Flash and 128 Byte of RAM on board [2]. Running at 16 MHz the controller consumes around 4 mA.

The USI (Universal Synchronous Interface) uses the SPI protocol which is also supported by the TLC5943. The GSKL clock is provided from a GPIO pin of the MSP430F2012 where it is derived from the controllers 16 MHz system clock. A DCO (Digitally Controlled Oscillator) in the microcontroller is software programmable and generates the system clock, an external crystal is not necessary.

The circuit runs at 3.3 V produced by a LDO LP2985A-33 [3] regulator from the 5 V to 8 V input voltage. The input voltage upper limit is governed by the maximum power dissipation  $P_{dmax}$  allowable in the LDO package. At 25 °C this is given as approximately 0.58 W. The maximum current  $I_{max}$  drawn by the MSP430 microcontroller and the three TLC5943 LED drivers (excluding LED current) is approximately 124 mA. This gives a maximum voltage drop across the regulator of around 4.7 V. The LEDs draw current directly from the input supply and are not always on so power dissipation in the driver chip output stage is low. As a rough guide for white LEDs with a forward voltage drop of 3.5 V and a current of 30 mA we can say that the ideal supply voltage for the circuit is 5 V.

These calculations are only valid if single LEDs are used as output loads but for applications using two or more in series it will be necessary to recalculate the supply voltage.

## The Software

Software for this project is written in C and was developed using the embedded workbench Kickstart from IAR systems. This

Constant Current Driver ON/OFF Tming in ES-PWM

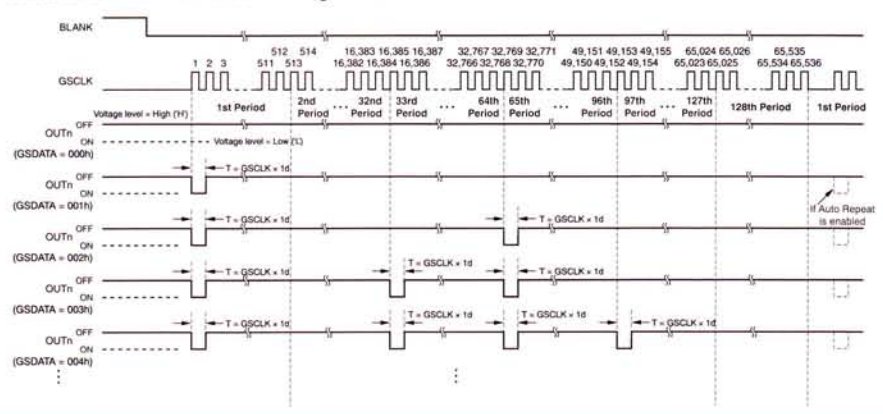

Figure 3. The value in the greyscale register (GSDATA) defines the on/off ratio of the PWM signal for each LED. Unlike standard PWM the on time is spread over the PWM period to reduce LED flicker.

complete development environment is free to use and can be downloaded from the TI home page [4] amongst others. This version allows a code size limit of 4 KB but is more than enough for this application.

The individual hardware components are initialised in the Main function of the code. The internal oscillator of the MSP430 runs at its maximum clock rate of 16 MHz. Once the GPIOs have been defined and the USI has been configured for SPI mode the global brightness value is sent to the brightness control register in each TLC5943 (the value of 127 used in the example software is the maximum).

As already mentioned the GCLK signal is derived from the microcontroller's system clock, the routine to configure this can be found in the Main function.

The MSP430's 16-bit timer is used to generate the clock which transfers data to and from the LED drivers. The routine to calculate new LED brightness values is called every time the 16-bit timer overflows at the beginning of every PWM period i.e. after 65536 GCLK periods or 4 ms approximately. The resulting interrupt causes the MSP430 to calculate new brightness values for each LED and send them to the TLC5943. When all the data has been sent a pulse on the XLAT input latches the data into the TLC5943's registers.

Storage of all the greyscale values for the LEDs requires 48 16-bit words. In order not to use up the precious RAM resources the software makes use of the fact that these values are stored in TLC5943 in serial form. The latest greyscale values are read back into the microcontroller using the serial interface; the next value is calculated and then sent back to the display drivers. In our case the calculation is quite simple; if an LED is part of a constellation the new value will be increased or decreased by a certain amount depending on whether the constellation is being faded in or out.

The constellation display is a cyclic 'State-Machine' with four states:

1. Background: All LEDs have equal background brightness. This is the transition phase between constellation depictions. Duration: 2 seconds.

## Construction

First off work out which constellations you wish to represent, the software can display up to eight different constellations.

To get the exact positions of each star in a constellation it is necessary to find an image file and transfer the coordinates of

the stars onto the display panel. The Internet is a good source of information here. Any LED can be used in any of the constellations (the software supports this). Each constellation can be rotated and scaled to make optimum use of the LEDs.

Once the positions are marked on the panel the holes can be drilled. To reduce the risk of splintering, place a piece of tape over the drill position and drill from the front of the panel. The drill size depends on the size of LED used. Once all the holes have been drilled use a larger drill with diameter equal to or slightly greater than the LED's shoulder to make a counterbore from the back of the panel. Do not go all the way through, the depth of counterbore governs how far the LED protrudes from the front of the panel. Once all the LED mounting holes have been drilled the outline shape of the panel can be decided and the panel trimmed accordingly. Finish off with a coat of paint. Fix each LED in position with a drop of wood glue or hot glue.

Wiring to the LEDs is not critical you can either connect the anodes of all the LEDs together and run a common wire back to the positive supply connection or run individual wires from the anode of each LED to the positive supply. When using the first option it is best not to have just one wire, this can give rise to flickering LEDs because current to all the switched LEDs passes through a single wire. The cathode of each LED can now be wired to output pins of the TLC5943 driver chips. Which LED is connected to which driver pin is not critical because the LED allocation for the constellations is taken care of in software. Finally fix the PCB to the back of the panel.

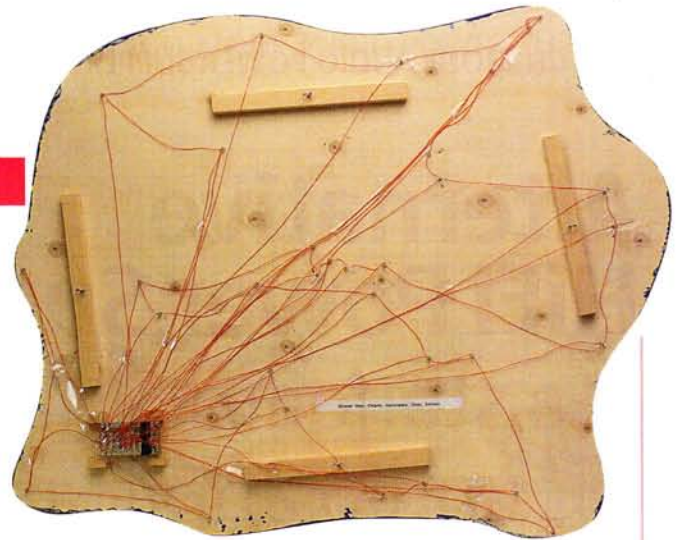

2. Fade in: Increase the brightness of the main stars in the displayed constellation. Duration: 5 seconds.
3. Constellation: The LEDs depicting the constellation stars are at full brightness. Duration: 3 seconds.
4. Fade out: Reduce the brightness of the main stars in the displayed constellation back to the background level. Duration: 5 seconds.

The software for this project can be freely downloaded from the Elektor site [5]. The program example depicts the constellations of Orion, Cassiopeia, The Swan, the Big Dipper and the Dolphin. The C source code can be edited for example constants given in the #define section such as background brightness level, maximum brightness of the constellation stars, display time of the constellations and the fade in/out time are just some of the simpler changes that can be made.

More suggestions can be found under the 'Software Modding' heading. Once the display is finished you can attach it to a wall and now you won't need to wait for a cool clear night to do a spot of star gazing, sit back in the warm and enjoy your own personal starry slide show.

(080895-1)

## Internet Links

- [1] <http://focus.ti.com/docs/prod/folders/print/tlc5943.html>
- [2] <http://focus.ti.com/docs/prod/folders/print/msp430f2012.html>
- [3] <http://focus.ti.com/docs/prod/folders/print/lp2985a-33.html>
- [4] <http://focus.ti.com/docs/toolsw/folders/print/jar-kickstart.html>
- [5] [www.elektor.com/080895](http://www.elektor.com/080895)

# Alternative HiFi Power Supplies

Is a standard SMPSU suitable for audio applications?

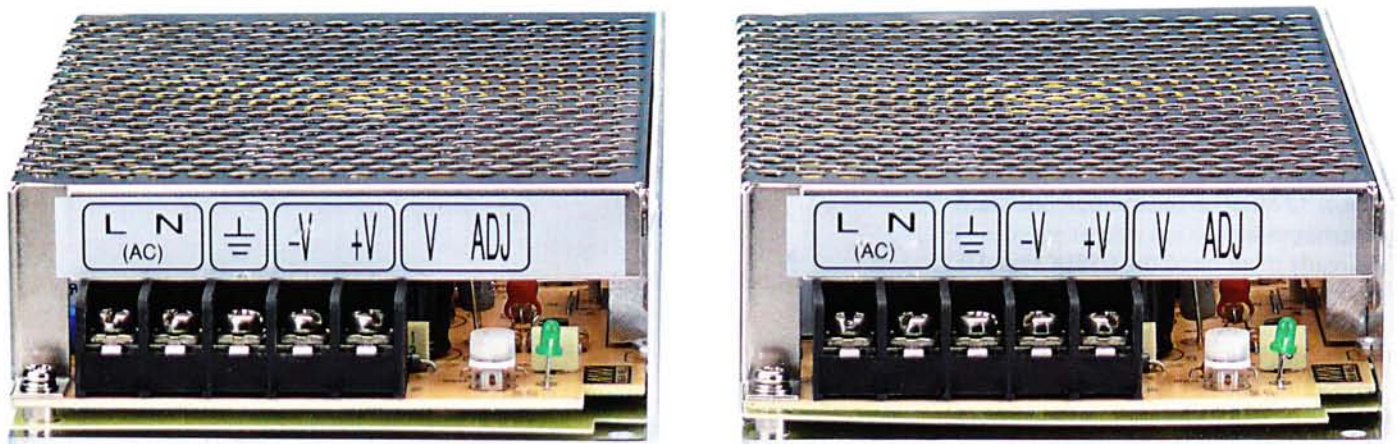

By Ton Giesberts (Elektor Labs) & Thijs Beckers (Elektor Netherlands Editorial), based on an idea by Dr. Thomas Scherer (Germany)

Why couldn't you just connect two standard switch-mode power supplies in series to create a symmetrical power supply for a power amplifier? What are the pitfalls and what do you need to look out for? And... is the quality acceptable?

Every (power) amplifier obviously needs a power supply. Up to now one would normally use a toroidal transformer with a bridge rectifier and a pair of heavy-duty electrolytic capacitors. Building your own switch-mode power supply is something few people would attempt at home. But iron is expensive and buying a toroidal transformer could easily cost you over £30. And that is before you've added several decent smoothing capacitors...

## Saving iron

We thought there had to be some other way. We had previously seen news items and datasheets on industrial switch-mode power supplies, but it wasn't clear how easy it was to incorporate them in our own circuits. The output voltage is usually fixed (often there were models with 12, 24 and 48 V outputs) and with just a single output. But why not combine two power supplies to create a symmetrical one?

The ridiculously low cost of these power supplies made it worthwhile to give it a try. So at the end of March we had four power supplies waiting for us in the test and measurement department of our lab.

## Proportions

Switch-mode power supplies are usually available with certain fixed output voltages and the trick is then to find a type that can deliver sufficient current to drive a 4 or 8  $\Omega$  loudspeaker up to the supply voltage rail. If we assume a load of 8  $\Omega$  this means that with a voltage of 24 V (a standard output with such power supplies) the power supply should be able to provide at least 3 A.

In practice, and especially with the output stage used here, we can assume there is a 'voltage drop' of about 3 V that occurs because the driver transistors cannot drive the output transistors up to the power rails. In this case a 2.6 A power supply should suffice.

We ordered four power supplies from the manufacturer Mean Well [1]: two of S-60-24 and two of LPS-75-24 so we could create two symmetrical power supplies for comparison. Industrial power supplies are often placed into 'power series': The S-60-24 tested by us comes from a series that are rated at 60 watts. In this series we find models with different output voltages and currents that all produce the same power output of 60 W. The LPS-75-24 comes from a 75 W series and is a bit more powerful.

### Test setup

To test the industrial switch-mode power supplies we connected up an IGBT power amplifier from the June 1995 issue. The operating voltage of this amplifier should really be 43 V, but the only part that had to be modified for use with the lower output voltage of the combined industrial power supplies was the power-up delay. This is set (via R35 in the original circuit diagram) to a 30 VAC voltage. If the Common of the power-up delay is connected directly to the common of the circuit and the positive side of C13 is connected directly to the supply voltage, the amplifier will also turn on with a lower supply voltage. The only part that doesn't function properly is the turning off of the relay when the supply is turned off, but this has no effect on the testing of the power supplies, so this doesn't matter.

We had a number of heavy-duty power resistors available to use as load for the power amplifier.

### In practice

Since most amplifiers, just as the IGBT power amplifier, require a symmetrical power supply, we require two (single-output) modules. These are connected in series, where the junction becomes the Common and the remaining positive and negative outputs become the supply voltages. The modules that we tested have a floating output. This means that there is no reference to a common Earth (US: Ground) so there won't be any unintended shorts.

When we chose our power supplies we assumed that they could be overloaded somewhat before their output voltage would drop. In the first test we loaded the S-60-24 with a nominal power resistor (24 V across 8  $\Omega$  results in 72 W!). In this test it appeared that the voltage began to drop when more than 3 A was required (22 V across 7  $\Omega$ , which is still quite good). So far this power supply looks good for use in this application.

In the original circuit of the IGBT power amplifier there are two 10,000  $\mu$ F electrolytic capacitors on board, which decouple the supply voltage close to the power transistors as well as possible. When the amplifier was driven at full power at low frequencies around 20 Hz the power supplies weren't able to keep the large electrolytics fully charged, which caused a large and irregular ripple to appear on the supply lines. The peak current that the electrolytics required from the power supply was simply so large that it triggered the protection circuit of the modules. When these electrolytics were left out it resulted in an increase in distortion from the amplifier. A compromise was found where the electrolytics were replaced with 1000  $\mu$ F types. The distortion at 1 W/8  $\Omega$  and a bandwidth of 80 kHz then became slightly higher (0.042 % instead of 0.032 %).

During a standard distortion measurement with a bandwidth of 80 kHz, it was immediately noticeable that it returned a much higher value than when a normal power supply was used. The original IGBT power amplifier had a distortion figure of only 0.002 % when it was powered by a normal mains transformer, bridge rectifier and smoothing electrolytics. An FFT analysis of the spectrum of the output signal quickly confirmed the differences. In **Figure 1** you can see the complete spectrum up to 130 kHz. What stands out most are the frequency components above 20 kHz. These mostly

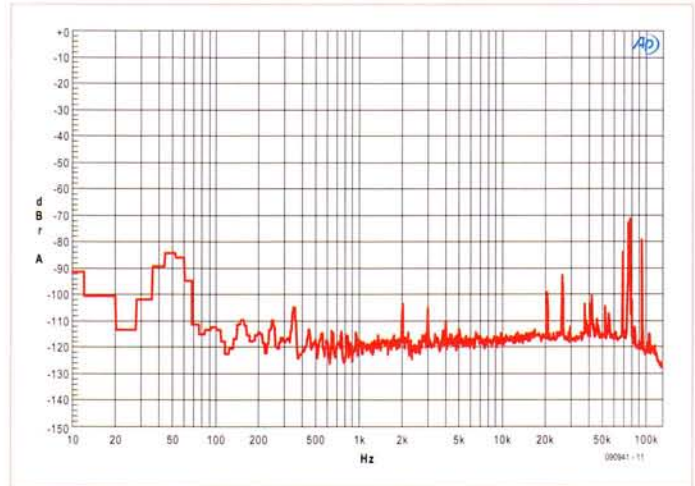

Figure 1. FFT of the output of the IGBT power amp when an S-60-24 is used as a power supply. The biggest interference peaks are still more than 70 dB below the test signal and are far outside the audio band.

originate from the power supply. They are, however, far outside the audio band. According to the datasheet of the power supply the S-60 series switches at 77 kHz, which can be clearly seen from the FFT measurement.

At higher audio power these frequency components become slightly less prominent and the harmonics of the audio signal take the upper hand. All components are at least 70 dB below the fundamental frequency (which was suppressed to achieve a lower noise floor in the FFT). This corresponds to less than 0.1  $\mu$ W!

**Figure 2** shows an enlargement of part of the spectrum. From here you can see that the two series connected power supplies don't have exactly the same switching frequency. It is not quite clear what the cause is of the two more distant components at 69 and 93 kHz, but we do know that they also originate from the power supplies. Under normal circumstances most power is required at lower frequencies. It is therefore interesting to find out how hard the amplifier can be driven at 20 Hz. For the S-60 the maximum output power

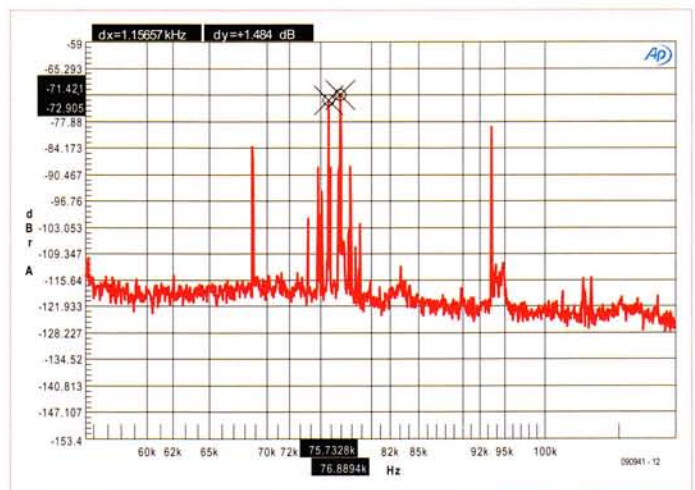

Figure 2. When we zoom in on the switching frequency we see several strange peaks from the S-60-24.

## SWITCH-MODE AUDIO POWER SUPPLIES

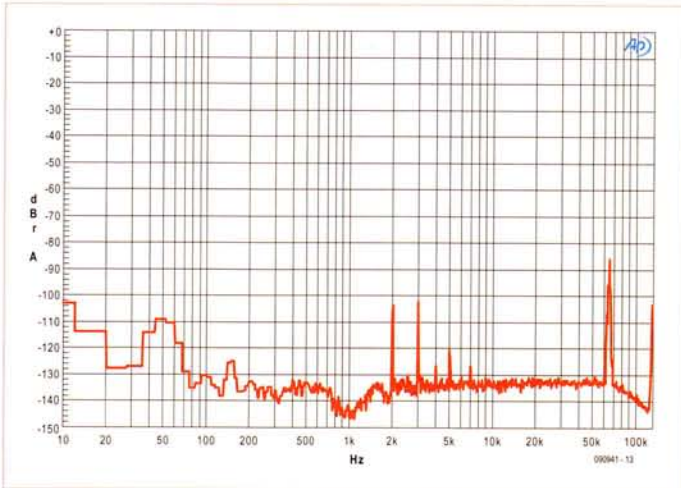

Figure 3. The FFT for the LPS-75-24 looks a lot tidier. There is virtually no interference from the residual switching frequency (88 dB below the reference signal).

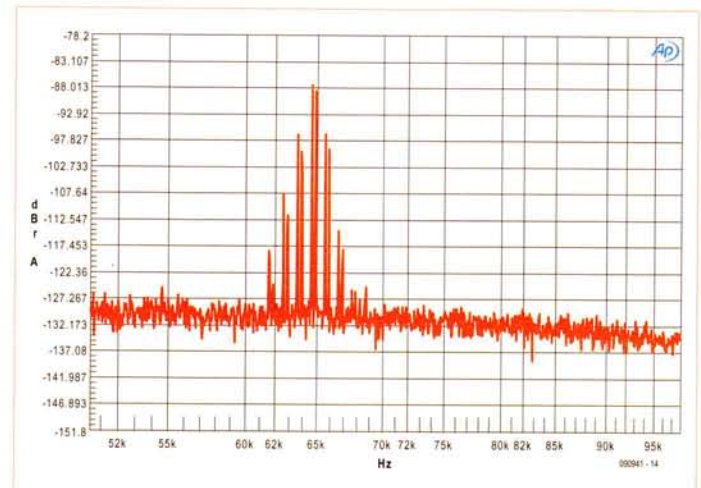

Figure 4. When we zoom in on the switching frequency we see that the LPS-75 has 'exemplary' behaviour.

at 20 Hz was 30 W into 8  $\Omega$ , 39 W into 6  $\Omega$ , 42 W into 5  $\Omega$  and 44 W into 4  $\Omega$  (THD+N = 0.1 %). At 1 kHz the maximum output power was 57 W into 4  $\Omega$  (54 W at 100 Hz). The lower the load impedance becomes, the more the output voltage of the power supply drops during the peak of the signal. It is clear that the power supply has reached its limits here.

### Comparisons

To get an idea if the spectrum we measured was typical of this type of power supply we also tested two modules from a different series, made by Mean Well. These were taken from the open series (no shielding), which could supply slightly more current: the LPS-75-24. This type was specified to deliver 3.2 A.

We also tested this power supply with a 'normal' resistor. The LPS-75-24 only started struggling (falling output voltage) when more than 4 A was demanded, which is 25 % above the value specified. With this type we could therefore use slightly lower load impedances.

The complete spectrum of the amplifier when used with this power supply (again, two modules were connected in series to create a symmetrical power supply) can be seen in **Figure 3**. It is noticeable that there is a much cleaner spectrum directly above the audio band (20 kHz and higher). In **Figure 4** you can see an enlargement of the frequencies around the switching frequency. The spectrum here contains fewer components (and with a smaller amplitude) than the S-60 version.

### Improvements?

The peak to peak ripple at the output of the S-60 power supply turned out to be slightly more than was stated in the datasheet, about 200 mV instead of 150 mV (ignoring any spikes). The first thing that came to mind when we wanted to improve on the results was to use a pair of chokes in series with the supply lines. Chokes of 64  $\mu\text{H}/3\text{ A}$  appeared to make very little difference in the FFT analysis and seemed to have an adverse effect on the distortion figures; these clearly became higher. Extra electrolytics also made things slightly worse, so there didn't appear to be a 'quick fix' to improve on the specifications.

This doesn't mean that these types of power supply are unsuitable

for audio applications. Despite the fact that the distortion in the frequency band up to 80 kHz is greater than when an 'analogue' supply is used, the effect of the noise from the switching frequency is negligibly (inaudibly) small as far as we're concerned. We're talking about 100 nanowatts at 77 kHz ...

From the measurements it appears that the LPS-75-24 works better than the S-60-24. It could be that the board layout of the modules is a reason for the difference between the two types. In the S-60 series the mains side is right next to the low-voltage output. In the LPS-75 series these connections are on opposite sides of a long, narrow board, which gives them an optimal separation. The shielding in the S-60 appears to have very little influence, although it is of course safer. However, on the S-60 the AC powerline connection and the low-voltage connection are on the same screw terminal block. On the LPS-75 half of the board is at AC live potential. On the downside, the connections on the LPS-75 series are on separate JST connectors, for which you have to find the appropriate plugs.

The biggest 'problem' with this type of module is that they have been designed with DC loads in mind. In a power amplifier the average current of a sine-wave over half a wave is about one third ( $I_{\text{max}}/\pi$ ) of the peak current (as long as the amplifier isn't over-driven). Considering the average power, one module for half of the power supply for the IGBT power amplifier with a 4  $\Omega$  load could be rated for half the power (between 30 to 40 W), as long as the power supply is able to deliver a peak current 3 times the average. This is something that the modules we tested couldn't do. The solution is to choose higher rated power supplies or ones that have been specially designed for audio use and that *can* supply higher peak currents (such as the SAPS-400 [2]).

At the end of the day, the tested power supplies weren't totally ideal, but they were inexpensive. The cost of the modules we tested was about £20 each. Try building a traditional power supply for this, with a transformer and large electrolytics!

(090941)

### Internet Links

[1] [www.meanwell.com](http://www.meanwell.com)

[2] [www.elektor.com/070688](http://www.elektor.com/070688)

# My Friend the Accelerometer

By Ed Simon (USA)

One of the tools of the acoustics trade is the accelerometer. Rarely seen, reasonably expensive and one of those tools you can't live without once you know it. In this article we not only get friendly with the relevant technology using low-cost components and DIY methods, we also get down to building a shaker table from an old woofer.

As you may know a change in distance per unit of time is velocity, and a change in velocity per unit of time is acceleration. Digikey's catalog listed a single axis model part #MSP1001 that costs less than \$50.00. It is a small ceramic package with three leads, and designed to be glued onto a test surface unlike the more general purpose units that can be screwed on. The unit arrived with a small calibration slip that said it produced 9.3 mV per G (that's Gravity not grams!). The manufacturer's website showed a typical preamp circuit to boost this to a more convenient level.

## The preamp

My take on this circuit is shown in **Figure 1**. Effectively the gain of the original circuit was modified so that my sensor produced either 0.1 V/G or 1.0 V/G. You could also change the second op-amp circuit into an integrator if you wanted a velocity output.

In my parts collection there was a miniature 4-pin Lemo connector set, so it got used for the input connector. BNC connectors are common in test gear so that became the output connector.

It was easy to make a small PC card for this circuit with two outputs, one 0.1 V per G and the other 1 V per G. A jumper cable from the card to the BNC connector allows for either to be used. It has stayed at 1 V/G as nothing so far has been above 1 G.

A small wall wart style 12 volt AC plug-in transformer seemed fine for the power supply. **Figure 2** shows the preamplifier with the parts mounted on a circuit board and the connectors installed.

## Applying the sensor

The sensor was epoxied to a small piece of wood to allow it to be screwed firmly to the device under test. I wanted a good solid hardwood, so a flitch of ebony from the scrap bin seemed to be perfect. Of course hickory, ash, or even hard maple would be good choices.

I then placed a small test loudspeaker on my bench with three sorbothane feet under it. After trying a few mounting methods for the sensor on a stick, double stick tape won! It seemed to give the same results as screws or clamps. I mounted the sensor to the top (shortest side), side and back of the case. Moving the sensor around gave pretty much the same curves. The minimum reading or background vibration level seemed to be about 5 or 6 milli-Gs.

The results for four of the loudspeaker tests are shown in **Figure 3**.

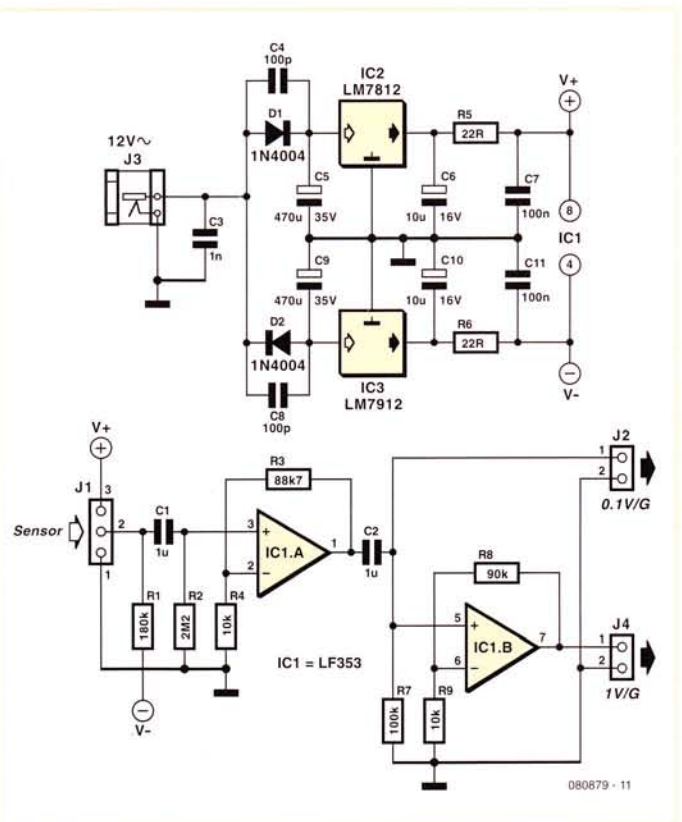

Figure 1. The preamplifier is designed to convert the accelerometer output into a signal with a 1 V/G or a 0.1 V/G gradient.

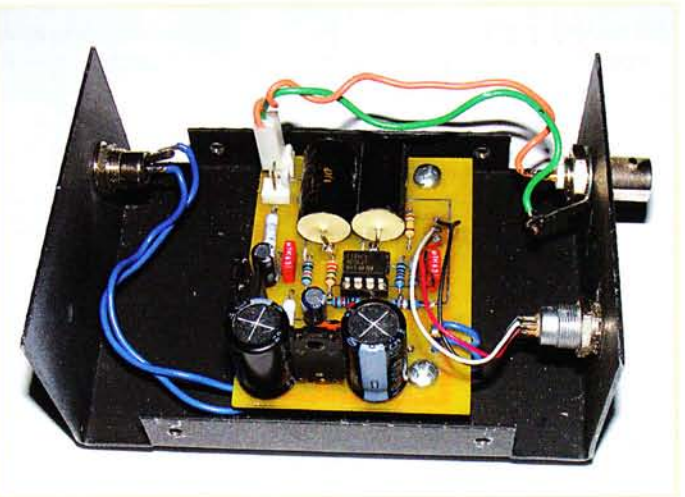

Figure 2. Assembled preamplifier in its case. Note the on-board rectifier and symmetrical supply section.

## EXPERIMENTAL ACOUSTICS

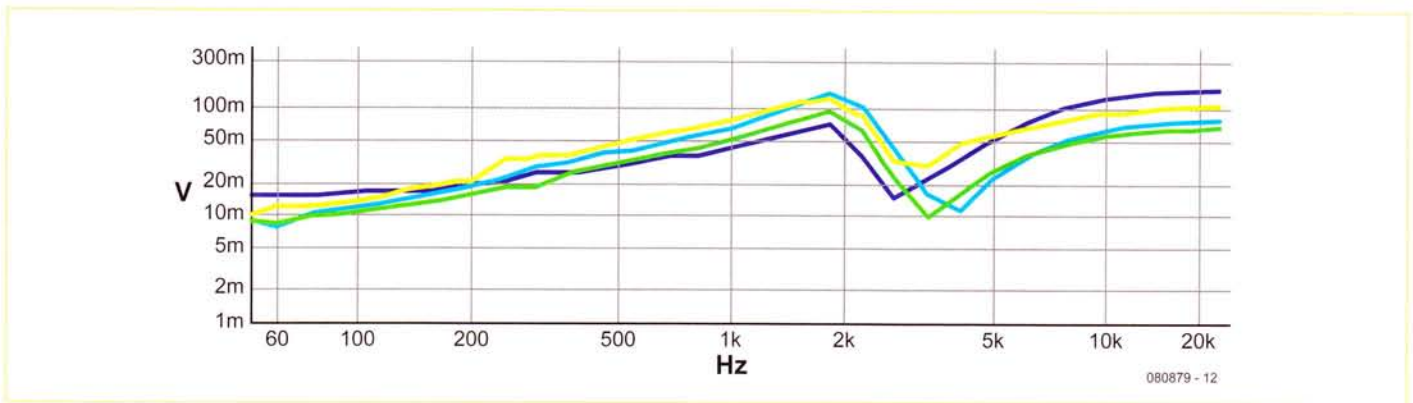

Figure 3. Frequency response measurements.

2-way 1" thick walnut bookshelf loudspeaker, top dead center	blue
Same loudspeaker long side centered	light blue
Same loudspeaker long side center of rear edge	green
Back	yellow

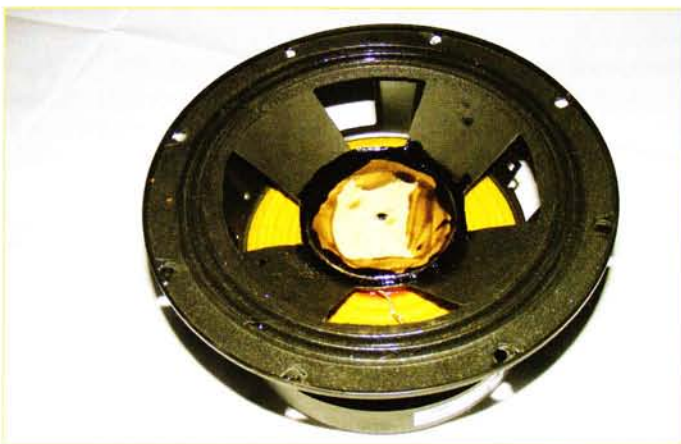

Figure 4. Use this homebrew shaker table to reveal some unexpected weaknesses of electronic components.

This showed that the case was solid with no spikes revealing cabinet buzzes. The crossover frequency was clearly evident. I wondered if I was seeing case vibrations or the energy response of the loudspeaker.

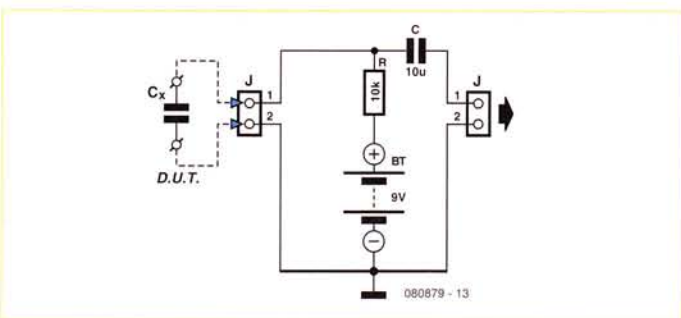

Figure 5. Biasing circuit for capacitors under test on the shaker table.

### Shake it!

The complementary piece of equipment for the accelerometer is the gizmo to move or shake things and then measure their response. I had a nice good condition JBL 2206 12" woofer that mishandling tore a large hole in the cone. Before reconing the loudspeaker it seemed reasonable to try it out as a shaker table. I cut off most of the cone, removed the dust cap and placed a 1/8" (3 mm) piece of ply wood across the voice coil.

Placing the accelerometer on the table showed this made a reasonably nice shaker table. It subjected the parts in audio gear (capacitors and resistors) to between 0.2 and 0.5 Gs depending on frequency. You could use a feedback system to make it more linear if you had a need.

I used Moyer loudspeaker cement to mount an assortment of capacitors and the accelerometer to the platform (Figure 4) I allowed this to dry overnight. I then used a 9-volt battery and a 10 kΩ 1/4 watt metal film resistor to bias the devices under test. The 'interface' circuit diagram is given in Figure 5. This was fed through another film capacitor to my Audio Precision test set. A Crown MA2400 amplifier was used to power the former JBL 2206 shaker table.

The test system moved things more than you should get just from sound pressure. A transformer in a power supply produced 0.2 Gs right where it was mounted but this should be less at the actual circuit card.

Your music system will have a gain of 20-odd dB in just the power amplifier. Some preamps add another 70 dB or even more! So if the test shows 500 microvolts at 0.5 Gs that could be 158 millivolts to your speakers at 5 milli-Gs!

The results were quit interesting. Figure 6 shows the results from two different mounting methods on two types of capacitors and the test leads shorted.

Large liquid filled capacitors were often less sensitive to vibration than other types. On rectangular capacitors the wide side was more sensitive than the narrow side. Round capacitors were not better than rectangular ones. Miniature capacitors did not do as well as the larger version.

Of course capacitors also have other differences besides vibration sensitivity. So this is certainly a design consideration but not the only one.



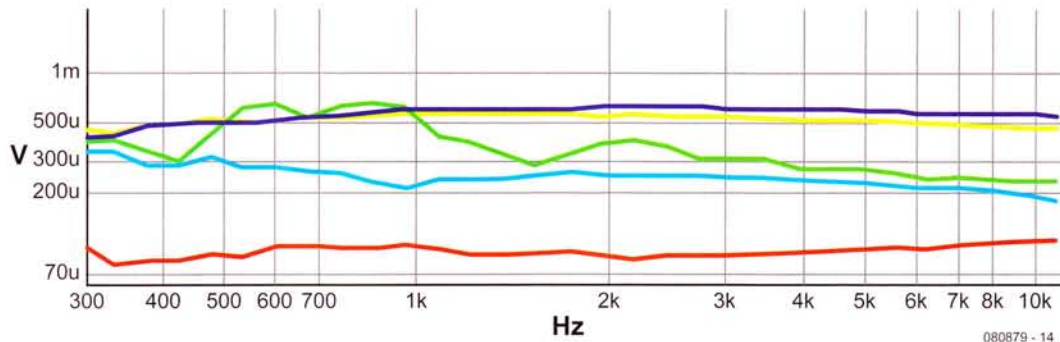

Figure 6. Capacitors on the shaker table.

	Sideways	PC Mounting
Panasonic 1uF 100V ECQE Series Metalized Polyester Film Rectangular Case	Light Blue	Green
Nichicon 10uF 25V VR Series Aluminum Electrolytic Miniature Radial Case	Yellow	Blue
Shorted Test Leads		Red

**Things to remember**

In short use as few motion sensitive parts as possible. Mount your capacitors so that the narrowest side is on axis with the most induced vibration. In active loudspeakers or just crossovers you

might want to decouple the circuit. Mechanically isolate or physically separate the power transformer. Finally don't use parts with high sensitivity in low level parts of a circuit.

(080879

Advertisement

# Python Programming and GUIs

Get started quickly and proceed rapidly

This book is aimed at people who want to interface PCs with hardware projects using graphic user interfaces. Desktop and web based applications are covered. The programming language used is Python, an object-oriented scripting language; a higher level language than, say, C. Obviously having fewer lines of code will be quicker to write but also fewer lines of code means fewer opportunities to make mistakes. Code will be more readable, and easier to modify at a later date. You can concentrate on the overall operation of the system you are making. This abstraction also applies when writing graphic user-interfaces. Writing low level code for graphics and mouse clicks and the like is something that you do not have to do. In Python all this is wrapped up in relatively simple functions. The book guides you through starting with Linux by way of a free downloadable, live bootable distribution that can be ported around different computers without requiring hard drive installation. Practical demonstration circuits and downloadable, full software examples are presented that can be the basis for further projects.

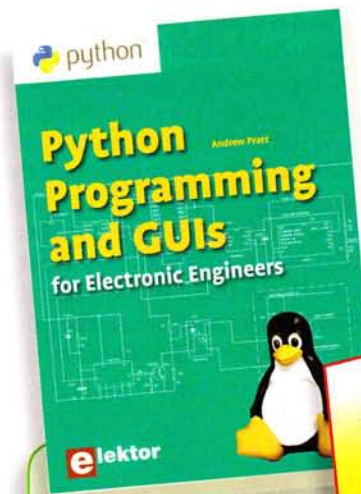

224 pages • ISBN 978-0-905705-87-3  
 £29.50 • US \$47.60

Elektor  
 Regus Brentford  
 1000 Great West Road  
 Brentford TW8 9HH  
 United Kingdom  
 Tel. +44 20 8261 4509

Further information and ordering at [www.elektor.com/shop](http://www.elektor.com/shop)

# Mini dice

By Petrus Bitbyter (The Netherlands)

There have been countless designs for electronic dice over the years, each attempting to outsmart the others. What's special about this mini dice is the minimal number of components needed: one chip, one capacitor, one pushbutton and seven LEDs. To keep everything small the author used SMD parts and a miniature circuit board for the prototype. Should you want to make it smaller still, then you could make an even tinier circuit board using smaller LEDs. But if you can't even see these so-called sprinkles then you may also use through-hole parts and a small piece of prototyping board.

All the work in this circuit is done with the PIC10F200, one of the smallest microcontrollers known to mankind. Nothing appears to happen when the circuit is first switched on, but after a button push the first number appears. With each subsequent push the dice closes its eyes (so it can think) and generates the next number. There has to be some time between two consecutive button pushes. If the button is pushed too soon the dice will not react. When the button is held too long, the dice will react when the button is released instead of when it is was first pushed.

The software is relatively straightforward. Using the built-in timer a clock of about 1 kHz is generated. The exact frequency is not terribly important, as long as it is stable. The clock drives a software counter which continuously counts from 1 to 6 and then wraps around. At the end of each clock period the software checks whether the pushbutton is pressed. If this is the case, the counter value at that instant is stored, and will be used as the next number. At the same time all the LEDs are turned off and two software timers are started. The first timer determines how long the LEDs remain off. When this timer expires the new number is displayed. The second timer determines the length of time before a new button push is accepted. As long as this timer is still counting it will not react to any new button pushes. If the button is still (or again) closed when the timer expires, then the release of the button is considered the command to produce a new number.

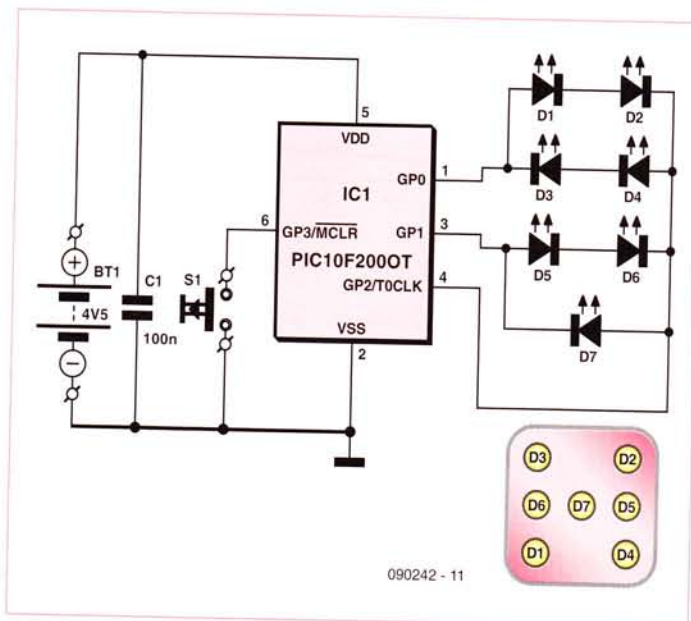

The supply voltage for the dice has to be somewhere between 3.5 and 5 V. You could use three AA alkalines or a 5-V power supply with a series diode. A little experimenting may be required because the light output is strongly dependent on the characteristics of the LEDs used. The drive to the LEDs is multiplexed and they are therefore not continuously on. The current is limited by the microcontroller. This reduces the number of components but does make the circuit more sensitive to changes in the power supply voltage.

(090242)

The source code and hex files for this project are available at [www.elektor.com/090242](http://www.elektor.com/090242).

The PCB layout in Eagle format can also be downloaded from there.

Advertisement

## Prototype & small series PCB specialists

**EURO**  
CIRCUITS

PCB proto	dedicated prototype service
STANDARD pool	widest choice 1 - 8 layers
<b>New</b> TECH pool	100 µm technology
<b>New</b> IMS pool	metal-backed PCBs
On demand	all options up to 16 layers

Call us: 020 8816 7005 Email: [euro@eurocircuits.com](mailto:euro@eurocircuits.com)

See us live at National Electronics Week – NEC booth F26

### ALL SERVICES

- Instant online pricing
- Instant online ordering
- Low pooling prices
- Deliveries from 2 days
- No tooling charges
- Stencil service

[www.eurocircuits.com](http://www.eurocircuits.com)

# NOW, THERE'S EVEN MORE TO DISCOVER.

NEW!



## The upgraded Elektor-PLUS subscription!

- All 11 issues including the Summer Circuits edition
- Included in your PLUS subscription: Annual DVD 2010
- **20%** cheaper than normal retail price
- Welcome gift worth £25
- Up to **40% discount** on selected Elektor products
- Elektor is delivered to your doorstep every month
- Read your copy before everyone else
- **NEW:** On your personalized Elektor PLUS website, you have permanent access to the three latest issues of the magazine in PDF format, as well as to a fast Elektor search engine!

**NEW:**  
exclusive access to  
[www.elektor-plus.com!](http://www.elektor-plus.com)

When taking out an Elektor PLUS subscription you get **exclusive access** to [www.elektor-plus.com](http://www.elektor-plus.com) where the three latest editions of Elektor magazine are available in the form of pdf files (i.e. the current issue and the two preceding ones). With a simple click you download the complete issue (front to back!) or any single article. [www.elektor-plus.com](http://www.elektor-plus.com) also supplies the most extensive Elektor search engine found on the web. However the upgraded PLUS subscription offers many more interesting extras like free E-books and supplementary articles.

[www.elektor.com/subs](http://www.elektor.com/subs) • Tel. +44 (0) 20 8261 4509

Or use the subscription order form near the end of the magazine.

**e**lektor

# Hexadoku

## Puzzle with an electronics touch

Summer is upon us and you should admit to having a bunch of outdoor activities to attend to besides working on your electronics projects and sending them to Elektor for publication. But surely there's an hour or two left to solve this month's Hexadoku! Send the hexadecimal numbers in the grey boxes to us and you automatically enter the prize draw for four Elektor Shop vouchers. Have fun!

The instructions for this puzzle are straightforward. Fully geared to electronics fans and programmers, the Hexadoku puzzle employs the hexadecimal range 0 through F. In the diagram composed of 16 × 16 boxes, enter numbers such that **all** hexadecimal numbers 0 through F (that's 0-9 and A-F) occur once only in each row, once

in each column and in each of the 4×4 boxes (marked by the thicker black lines). A number of clues are given in the puzzle and these determine the start situation. Correct entries received enter a draw for a main prize and three lesser prizes. All you need to do is send us the numbers in the grey boxes.

### Solve Hexadoku and win!

Correct solutions received from the entire Elektor readership automatically enter a prize draw for one Elektor Shop voucher worth £ 80.00 and three Elektor Shop Vouchers worth £ 40.00 each, which should encourage all Elektor readers to participate.

### Participate!

Before July 1, 2010, send your solution (the numbers in the grey boxes) by email, fax or post to

Elektor Hexadoku – 1000, Great West Road – Brentford TW8 9HH  
United Kingdom.

Fax (+44) 208 2614447

Email: [hexadoku@elektor.com](mailto:hexadoku@elektor.com)

### Prize winners

The solution of the April 2010 Hexadoku is: DFB12.

The £80.00 voucher has been awarded to: Gerhard Dum (Austria).

The £40.00 vouchers have been awarded to: Mark A. Saywell (UK), Anton Loffeld (USA) and Gabi & Thomas Riester (Germany).

Congratulations everyone!

		7	4	8										3		6		9
8	C	2								9						0		
				0				C	5		1							
0	1	B		E	C	7	9				A							F
	3		F			C				5								6
		1	2		F	0	A	4	9					B	5	3		
	A	6				9	3	B		1	7	8	E	2	4			
7	4			6		B		A	3	C				9	D			
A					D								C	E		9	2	
2				1		3			4		F							
6	D		3		E				8					F	B	C		
		4							A							7	6	
	6		8	3		D	7					0					F	
				4	9			5					6	1	0	E		
9						E	2	F		8	4		7					
		F	5	C	A				7	6	3					4	8	

(c) PZZL.com

5	8	B	E	D	A	9	C	4	7	2	6	F	3	0	1			
1	2	C	6	4	7	E	8	3	0	D	F	5	B	A	9			
A	9	4	3	F	6	B	0	C	1	5	8	E	D	7	2			
7	F	0	D	1	3	5	2	E	B	9	A	6	C	4	8			
0	5	F	C	E	2	4	A	6	9	1	3	B	8	D	7			
4	6	9	7	0	8	3	B	2	A	C	D	1	E	F	5			
2	B	8	1	9	D	C	F	0	5	7	E	3	A	6	4			
E	D	3	A	7	5	1	6	B	8	F	4	9	2	C	0			
B	E	7	5	2	0	F	1	8	D	6	C	4	9	3	A			
D	3	1	9	C	4	A	E	7	F	B	2	8	0	5	6			
8	C	6	2	3	9	D	5	A	4	0	1	7	F	E	B			
F	0	A	4	6	B	8	7	9	E	3	5	D	1	2	C			
9	1	5	B	A	C	0	3	F	6	E	7	2	4	8	D			
3	4	2	8	5	E	7	9	D	C	A	B	0	6	1	F			
C	7	E	0	8	F	6	D	1	2	4	9	A	5	B	3			
6	A	D	F	B	1	2	4	5	3	8	0	C	7	9	E			

The competition is not open to employees of Elektor International Media, its business partners and/or associated publishing houses.

# elekterminal (1978)

By Antoni Gendrau (Spain)

Many moons ago, computers were unsophisticated — they had very poor graphic screens, and text screens were even worse. In the early 1980s I owned a Superboard II computer. It was based on a Rockwell 6502 microprocessor, and the text screen had a 'superb' 30x30 characters resolution. As an aside, this computer featured a Microsoft BASIC interpreter (in only 8 Kbytes of ROM), that was probably written by Bill Gates himself. I used it for a while for programming, gaming and typewriting, but soon realized that 30 characters per line wasn't enough for some jobs on hand.

When I was thinking how to improve my text screen, I suddenly remembered I had a copy Elektor's December 1978 edition, with an article about a project called *elekterminal* (*sic*) — a 'dumb' ASCII VDU provided with a serial interface and capable of displaying 16 lines x 64 characters. The whopping 64 characters per line for the first time allowed me to write real lines of text and to understand program code more easily. Furthermore, the serial port enabled me to leave the computer in my lab and access it from any room in my home thanks to the *elekterminal*. All quite essential — because my Superboard had put on weight due to several 'improvements' and expansion cards added over time.

When I decided to build the *elekterminal*, I was faced with three major problems: the components, the printed circuit board and an outlandish device called PROM. I barely had heard of programmable devices before!

Firstly I tried to find all the necessary components, and surprisingly, I was successful in local shops. At that time electronics retail outlets were numerous, although with hindsight the number of devices stocked was limited.

Secondly, the PCB. With my budget best described as 'really small', and Elektor kind enough to print the PCB copper track layout in the article, I decided to make the board myself, using the traditional method, i.e. photocopying the Elektor page containing the PCB design onto a piece of transparent film, then applying the film over a piece of photosensitive board and finally exposing the solder side of the circuit board to about 45 seconds worth of UV light from the sun. Lastly I etched away the unwanted copper using hydrochloric acid and hydrogen peroxide. The result: a perfect single sided PCB.

And finally, the PROM. The device is used to assist the CRTC chip in deciding which ASCII characters are used to erase the screen (CLS), go one line down (LF), and many other special functions. Sadly I didn't have a PROM programmer, and the formidable task of programming 1,024 bits of data manually (and without errors) looked like an impossible mission. What to do? Mulling over the problem, I realised that the first half of the memory space was blank, and in the second half only 34 characters (136 bits) had to be programmed. Now the problem was down to the timing. To program a bit, a very short pulse must be supplied to a PROM pin. I tried with a pushbutton, pressing it as fast as I could, and... it worked!

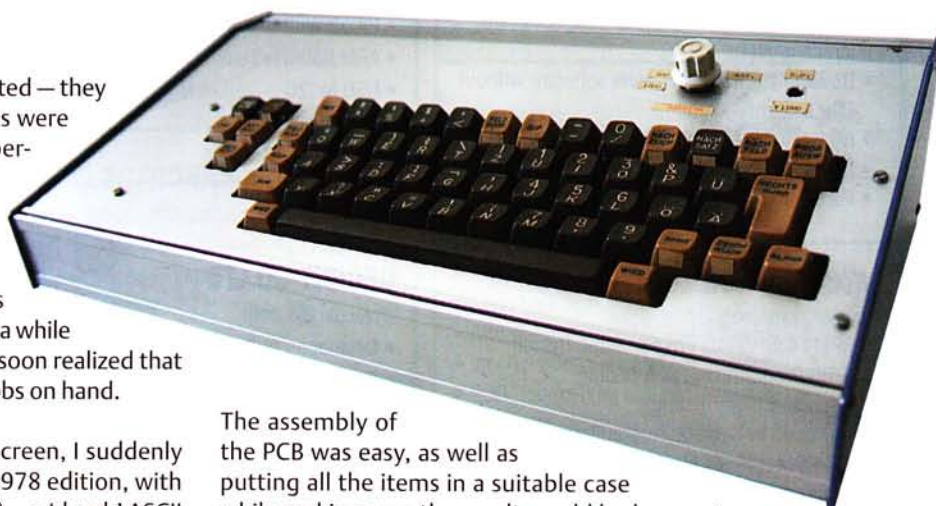

The assembly of the PCB was easy, as well as putting all the items in a suitable case while making sure the result would look acceptable, as shown in the picture.

Usually, the first time power up of a homebrew circuit is a thrill, but I was not less excited when I carried my *elekterminal* from the attic for examination and to write this piece for the Retronics series. I powered up, and Eureka! The familiar screen full of gobbledygook appeared again. Nope, *elekterminal* has no provision to erase the screen RAM at power up! Oh dear, my version of the power supply had two 7805 regulators connected in parallel — definitely not something I would do today!

Inspired by Elektor's December 2009 edition on home automation standards, and using AC power line signalling I managed to connect equipment to the *elekterminal* without a long RS-232 cable. I was able to communicate at 1200 baud with a simple circuit. The idea is to modulate a fixed frequency for 1, and nothing for 0. At the far side, a filter tuned to the frequency transmitted recovers the logic 1's. Today I am working on designs to automate my home using the *elekterminal* as a portable programming unit — giving it a second lease of life.

(100117)

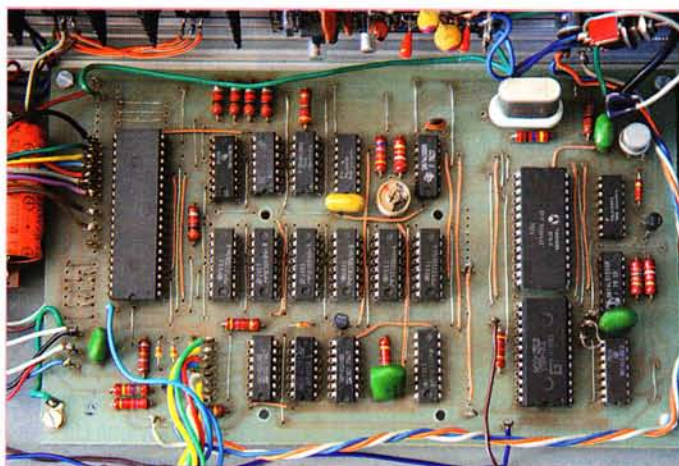

*Retronics* is a monthly column covering vintage electronics including legendary Elektor designs. Contributions, suggestions and requests are welcomed; please send an email to [editor@elektor.com](mailto:editor@elektor.com)

# ELEKTOR SHOWCASE

To book your showcase space contact Huson International Media

Tel. 0044 (0) 1932 564999 Fax 0044 (0) 1932 564998

## ASTROBE V3.0

[www.astrobe.com](http://www.astrobe.com)

Windows Development System for LPC2000 microcontrollers.

- Develop high-and low-level software without C or assembler
- Generate fast 32-bit native ARM code
- No special programming hardware required
- Personal, Standard and Professional Editions

## ATOMIC PROGRAMMING LTD

[www.atomicprogramming.com](http://www.atomicprogramming.com)

- AP-114 ISP/JTAG Programming System
- JTAG Programming and Testing
- Boundary Scan Testing
- Universal In-System Programming
- EEPROM and SPI Flash Out-of-Circuit Programming
- Generic GDB Proxy Server
- Jennic JN5148 ZigBee Development Applications
- Training Platform available



## AVIT RESEARCH

[www.avitresearch.co.uk](http://www.avitresearch.co.uk)

USB has never been so simple... with our USB to Microcontroller Interface cable. Appears just like a serial port to both PC and Microcontroller, for really easy USB connection to your projects, or replacement of existing RS232 interfaces.



See our webpage for more details. From £10.00.

## BETA LAYOUT

[www.pcb-pool.com](http://www.pcb-pool.com)

Beta layout Ltd Award-winning site in both English and German offers prototype PCBs at a fraction of the cost of the usual manufacturer's prices.



## BLACK ROBOTICS

[www.blackrobotics.com](http://www.blackrobotics.com)

Robot platforms and brains for research, hobby and education.

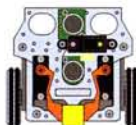

- Make your robot talk!
- TalkBotBrain is open-source
- Free robot speech software
- Robot humanisation technology
- Mandibot Gripper Robot

## ByVac

[www.byvac.com](http://www.byvac.com)

- PIC32 With BASIC
- ARM With Forth
- USB to I2C
- Serial Devices
- VT100 LCD Displays



## DECIBIT CO.LTD

[www.decibit.com](http://www.decibit.com)

- Development Kit 2.4 GHz
- Transceiver nRF24L01
- AVR MCU ATmega168



## CEDA

[www.ceda.in](http://www.ceda.in)

ceda@vsnl.com

**CEDA e-learning**  
PADS | OrCAD | ALLEGRO  
PCB layout @ \$5 Hourly

- PCB Layout @ \$5 Hourly
- Learn PCB Designing with Multimedia DVD in OrCAD, PADS & ALLEGRO
- Self or e-learning with support by email, phone & web-meeting

## DESIGNER SYSTEMS

<http://www.designersystems.co.uk>

Professional product development services.

- Marine (Security, Tracking, Monitoring & control)
- Automotive (AV, Tracking, Gadget, Monitoring & control)
- Industrial (Safety systems, Monitoring over Ethernet)
- Telecoms (PSTN handsets, GSM/GPRS)
- AudioVisual ((HD)DVD accessories & controllers)

Tel: +44 (0) 845 5192306

## EASYSYNC

<http://www.easysync.co.uk>

EasySync Ltd sells a wide range of single and multi-port USB to RS232/RS422 and RS485 converters at competitive prices.



## ELNEC

[www.elnec.com](http://www.elnec.com)

Europe's leading device programmers manufacturer:

- reliable HW:  
3 years warranty for most programmers
- support over 52.000 devices
- free SW updates
- SW release: few times a week
- excellent technical support:  
Algorithms On Request, On Demand SW
- all products at stock / fast delivery



## FIRST TECHNOLOGY TRANSFER LTD.

<http://www.ftt.co.uk>

- Training and Consulting for IT, Embedded and Real Time Systems
- Assembler, C, C++ (all levels)
- 8, 16 and 32 bit microcontrollers
- Microchip, ARM, Renesas, TI, Freescale
- CMX, uCOSII, FreeRTOS, Linux operating systems
- Ethernet, CAN, USB, TCP/IP, Zigbee, Bluetooth programming



## FLEXIPANEL LTD

[www.flexipanel.com](http://www.flexipanel.com)

TEAclippers - the smallest PIC programmers in the world, from £20 each:

- Per-copy firmware sales
- Firmware programming & archiving
- In-the-field firmware updates
- Protection from design theft by subcontractors



## HAMEG Instruments

A Rohde & Schwarz Company

- Oscilloscopes
- Power Supplies
- Spectrum Analyzers
- RF Instruments
- Programmable Measuring Instruments

Great Value in Test & Measurement

[www.hameg.com](http://www.hameg.com)

# products and services directory

## FUTURE TECHNOLOGY DEVICES

<http://www.ftdichip.com>

FTDI designs and sells USB-UART and USB-FIFO interface i.c.'s.

Complete with PC drivers, these devices simplify the task of designing or upgrading peripherals to USB



## MQP ELECTRONICS

[www.mqp.com](http://www.mqp.com)

- Low cost USB Bus Analysers
- High, Full or Low speed captures
- Graphical analysis and filtering
- Automatic speed detection
- Bus powered from high speed PC
- Capture buttons and feature connector
- Optional analysis classes



[www.elektor.com](http://www.elektor.com)

## HEXWAX LTD

[www.hexwax.com](http://www.hexwax.com)

World leaders in Driver-Free USB ICs:

- USB-UART/SPI/I2C bridges
- TEAleaf-USB authentication dongles
- expandIO-USB I/O USB expander
- USB-FileSys flash drive with SPI interface
- USB-DAQ data logging flash drive

## ROBOT ELECTRONICS

<http://www.robot-electronics.co.uk>

Advanced Sensors and Electronics for Robotics

- Ultrasonic Range Finders
- Compass modules
- Infra-Red Thermal sensors
- Motor Controllers
- Vision Systems
- Wireless Telemetry Links
- Embedded Controllers



## ROBOTIQ

<http://www.robotiq.co.uk>

Build your own Robot!

Fun for the whole family!

Now, available in time for X-mas

- Arduino Starter Kits \*NEW!!\*
  - Lego NXT Mindstorms
  - Affordable Embedded Linux Boards
  - Vex Robotics (kits and components)
  - POB Robots (kits and components)
- email: [sales@robotiq.co.uk](mailto:sales@robotiq.co.uk) Tel: 020 8669 0769



## RFID COMPONENTS

<http://www.apdanglia.org.uk>

For DIY, OEM's & Experimenters

- EM4100 Cards .99 p (Prices inc vat)
  - Keyfobs £1.09
  - R/W Keyfobs £1.65
  - RFID Coils £2.95
  - RFID PCB with RS232 port
  - RFID IC's EM4095 - U2270B
  - microRFID module (similar to Core ID12)
  - Free Reader download - Technical pages
- Order online 24 hrs - Tel: 01244 520684



## USB INSTRUMENTS

<http://www.usb-instruments.com>

USB Instruments specialises in PC based instrumentation products and software such as Oscilloscopes, Data Loggers, Logic Analysers which interface to your PC via USB.



## VIRTINS TECHNOLOGY

[www.virtins.com](http://www.virtins.com)

PC and Pocket PC based virtual instrument such as sound card real time oscilloscope, spectrum analyzer, signal generator, multimeter, sound meter, distortion analyzer, LCR meter. Free to download and try.

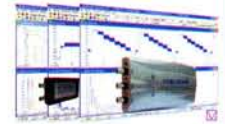

## SHOWCASE YOUR COMPANY HERE

Elektor Electronics has a feature to help customers promote their business. Showcase - a permanent feature of the magazine where you will be able to showcase your products and services.

- For just £242 + VAT (£22 per issue for eleven issues) Elektor will publish your company name, website address and a 30-word description
- For £363 + VAT for the year (£33 per issue for eleven issues) we will publish the above plus run a 3cm deep full colour

image - e.g. a product shot, a screen shot from your site, a company logo - your choice

Places are limited and spaces will go on a strictly first come, first served basis. So-please fax back your order today!

I wish to promote my company, please book my space:

- Text insertion only for £242 + VAT
- Text and photo for £363 + VAT

NAME: ..... ORGANISATION: .....

JOB TITLE: .....

ADDRESS: .....

TEL: .....

PLEASE COMPLETE COUPON BELOW AND FAX BACK TO 00-44-(0)1932 564998

COMPANY NAME: .....

WEB ADDRESS: .....

30-WORD DESCRIPTION: .....

.....

.....

.....

.....

.....

.....

.....

# Going Strong

A world of electronics from a single shop!

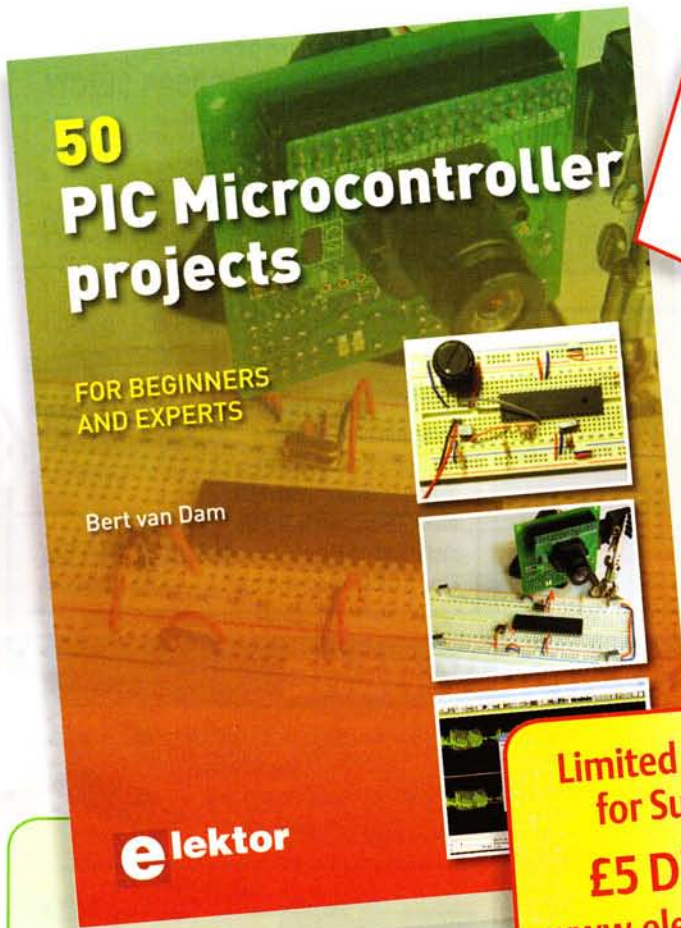

**NEW!**

Limited Period Offer for Subscribers!  
**£5 DISCOUNT**  
[www.elektor.com/june](http://www.elektor.com/june)

Books

A laser alarm, USB teasing mouse, soundswitch and much more

## 50 PIC Microcontroller projects

This book contains 50 fun and exciting projects for PIC microcontrollers such as a laser alarm, USB teasing mouse, egg timer, youth repellent, soundswitch, capacitive liquid level gauge, "finger in the water" sensor, guarding a room using a camera, mains light dimmer (110-240 volts), talking microcontroller and much more. Several different techniques are discussed such as relay, alternating current control including mains, I2C, SPI, RS232, USB, pulse width modulation, rotary encoder, interrupts, infrared, analog-digital conversion (and the other way around), 7-segment display and even CAN bus. Three PIC microcontrollers are used in this book, the 16f877A, 18f4455 and 18f4685. It is also discussed how you can migrate your project from one microcontroller to another - 15 types are supported - including two example projects.

440 pages • ISBN 978-0-905705-88-0 • £36.00 • US \$58.10

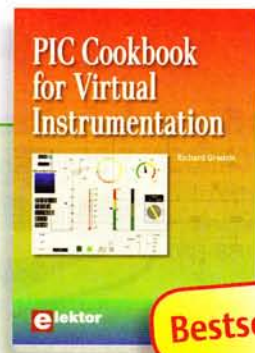

Several case studies included

## PIC Cookbook for Virtual Instrumentation

The software simulation of gauges, control-knobs, meters and indicators which behave just like real hardware components on a PC's screen is known as virtual instrumentation. In this book, the Delphi program is used to create these mimics and PIC based external sensors are connected via a USB/RS232 converter communication link to a PC. Case studies of virtual instruments are detailed including a compass, an oscilloscope, a digital and analogue thermometer and virtual displays for cars and aircraft.

264 pages • ISBN 978-0-905705-84-2  
 £29.50 • US \$47.60

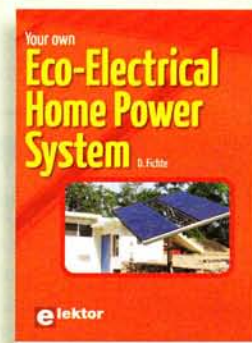

Home electric power

## Your own Eco-Electrical Home Power System

This book provides the semi-technical, power-conscious homeowner a place to begin in the quest for home electric power. Both the essential principles and detailed information on how to build or maintain a home electric system off the utility grid are presented in an easy-going style. This booklet will help you to safeguard or develop your own home electricity supply. It contains step-by-step calculations, practical details, examples and much more.

75 pages • ISBN 978-0-905705-82-8  
 £16.50 • US \$26.70





**Microsoft approved!**

Learn more about C# programming and .NET

## C# 2008 and .NET programming

This book is aimed at Engineers and Scientists who want to learn about the .NET environment and C# programming or who have an interest in interfacing hardware to a PC. The book covers the Visual Studio 2008 development environment, the .NET framework and C# programming language from data types and program flow to more advanced concepts including object oriented programming.

240 pages • ISBN 978-0-905705-81-1  
£29.50 • US \$47.60



Circuit design and programming

## Complete practical measurement systems using a PC

This book covers both hardware and software aspects of designing typical embedded systems based on personal computers running the Windows operating system. It's use of modern techniques in detailed, numerous examples has been designed to show clearly how straightforward it can be to create the interfaces between digital and analog electronics, programming and Web-design. Readers are encouraged by examples to program with ease; the book provides clear guidelines as to the appropriate programming techniques "on the fly".

292 pages • ISBN 978-0-905705-79-8  
£28.50 • US \$46.00

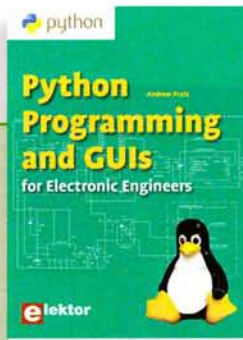

Get started quickly and proceed rapidly

## Python Programming and GUIs

This book is aimed at people who want to interface PCs with hardware projects using graphic user interfaces. Desktop and web based applications are covered. The programming language used is Python, an object-oriented scripting language; a higher level language than, say, C. Obviously having fewer lines of code will be quicker to write but also fewer lines of code means fewer opportunities to make mistakes. Code will be more readable, and easier to modify at a later date. You can concentrate on the overall operation of the system you are making. This abstraction also applies when writing graphic user-interfaces. Writing low level code for graphics and mouse clicks and the like is something that you do not have to do. In Python all this is wrapped up in relatively simple functions. The book guides you through starting with Linux by way of a free downloadable, live bootable distribution that can be ported around different computers without requiring hard drive installation.

224 pages • ISBN 978-0-905705-87-3  
£29.50 • US \$47.60

More information on the  
Elektor Website:

[www.elektor.com](http://www.elektor.com)

Elektor  
Regus Brentford  
1000 Great West Road  
Brentford  
TW8 9HH  
United Kingdom  
Tel.: +44 20 8261 4509  
Fax: +44 20 8261 4447  
Email: [sales@elektor.com](mailto:sales@elektor.com)



A whole year of Elektor magazine  
onto a single disk

## DVD Elektor 2009

This DVD-ROM contains all editorial articles published in Volume 2009 of the English, American, Spanish, Dutch, French and German editions of Elektor. Using the supplied Adobe Reader program, articles are presented in the same layout as originally found in the magazine. An extensive search machine is available to locate keywords in any article. With this DVD you can also produce hard copy of PCB layouts at printer resolution, adapt PCB layouts using your favourite graphics program, zoom in / out on selected PCB areas and export circuit diagrams and illustrations to other programs.

ISBN 978-90-5381-251-8  
£17.50 • US \$28.30



110 issues, more than 2,100 articles

## DVD Elektor 1990 through 1999

This DVD-ROM contains the full range of 1990-1999 volumes (all 110 issues) of Elektor Electronics magazine (PDF). The more than 2,100 separate articles have been classified chronologically by their dates of publication (month/year), but are also listed alphabetically by topic. A comprehensive index enables you to search the entire DVD.

ISBN 978-0-905705-76-7  
£69.00 • US \$111.30

CD/DVD-ROMS



See the light on Solid State Lighting

### DVD LED Toolbox

This DVD-ROM contains carefully-sorted comprehensive technical documentation about and around LEDs. For standard models, and for a selection of LED modules, this Toolbox gathers together data sheets from all the manufacturers, application notes, design guides, white papers and so on. It offers several hundred drivers for powering and controlling LEDs in different configurations, along with ready-to-use modules (power supply units, DMX controllers, dimmers). In addition to optical systems, light detectors, hardware, etc., this DVD also addresses the main shortcoming of power LEDs: heating. This DVD contains more than 100 articles on the subject of LEDs.

ISBN 978-90-5381-245-7  
 £28.50 • US \$46.00



Elektor's Components Database 5

### cd ECD 5

The program package consists of eight databanks covering ICs, germanium and silicon transistors, FETs, diodes, thyristors, triacs and optocouplers. A further eleven applications cover the calculation of, for example, LED series droppers, zener diode series resistors, voltage regulators and AMVs. A colour band decoder is included for determining resistor and inductor values. ECD 5 gives instant access to data on more than 69,000 components. All databank applications are fully interactive, allowing the user to add, edit and complete component data.

ISBN 978-90-5381-159-7  
 £24.90 • US \$40.20



New!

### dsPIC Control Board

(May 2010)

This control board has been designed for incorporation into typical industrial electronics applications like controlling motors or adjustment of static up- or down-converters. The objectives were to obtain a board with a large number of pulsewidth modulation (PWM) generators, which enables us to control several motors and static converters at the same time. The cost of the control board needed to be as low as possible too. In addition, it must be possible to construct the board using a soldering iron, without requiring use of a reflow oven.

PCB, populated and tested

Art.# 090073-91 • £140.00 • US \$225.90



### In-vehicle CO<sub>2</sub> Meter

(May 2010)

The CO<sub>2</sub> Meter published in our January 2008 edition continues to operate very well, so why bother to do a new design? The answer is both simple and obvious. In the previous article, we mentioned that too high a concentration of CO<sub>2</sub> negatively affects the ability to concentrate. And in which daily activity does the ability to concentrate play an important role? Exactly! While driving a car (excluding convertibles). We therefore developed a CO<sub>2</sub> meter that is suitable for in-car use.

Kit of parts, including sensor and LCD (excl. enclosure)

Art.# 0100020-71 • £137.00 • US \$221.00

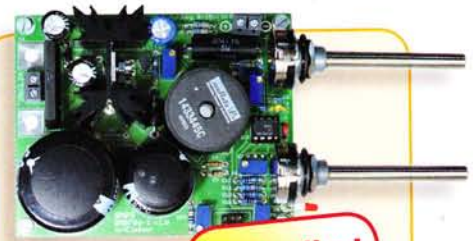

Bestseller!

### UniLab

(April 2010)

A power supply with adjustable output voltage and current limiting is part of the basic equipment of every electronics lab. However, the increased complexity of a switch-mode design scares away many potential builders, even though it actually isn't all that complicated if you use a suitable combination of well-known technologies. This circuit is suitable for building a single or dual power supply.

PCB and all components, less power transformer

Art.# 090786-71 • £64.00 • US \$103.30



Price slashed!

### Reign with the Sceptre

(March 2010)

This open-source & open-hardware project aims to be more than just a little board with a big microcontroller and a few useful peripherals — it seeks to be a fast prototyping system. To justify this title, in addition to a very useful little board, we also need user-friendly development tools and libraries that allow fast implementation of the board's peripherals. Ambitious? Maybe, but nothing should deter you from becoming Master of Embedded Systems Universe with the help of the Elektor Sceptre.

PCB, populated and tested, test software loaded (excluding Bluetooth module)

Art.# 090559-91 • £89.00 • US \$143.60

June 2010 (No. 402) £    US\$

**OBD2 Mini Simulator**  
Virtual car supports PWM/ISO/KWP2000  
080804-71 .... Kit of parts ..... 84.00.....135.50

**Wireless Electricity meets RFID**  
100051-71 .... Kit of parts, containing 3 PCBs (RFID Tag, debugger and reader), 2 programmed micro-controllers and 080910-91 module ..... www.elektor.com

**InterSceptre opens doors (and ports!) for you**  
100174-71 .... Kit of parts, contains PCB and components ..... www.elektor.com

May 2010 (No. 401)

**dsPIC Control Board**  
090073-91 .... PCB, populated and tested ..... 140.00.....225.90

**Cloud Altitude Meter**  
090329-91 .... Populated PCB in enclosure (see poll)..... www.elektor.com

**In-vehicle CO<sub>2</sub> Meter**  
100020-71 .... Kit of parts ..... 137.00.....221.20  
100020-72 .... Enclosure ..... 19.00.....30.70

**VisiOLED**  
081141-1 ..... Printed circuit board..... 13.30.....21.50

April 2010 (No. 400)

**UniLab**  
090786-1 ..... Printed circuit board..... 16.00.....25.90  
090786-71 .... PCB and all components, less power transformer ..... 64.00.....103.30

**Small is Beautiful: Minimod18**  
090773-41 .... Programmed controller with Bootloader pre-programmed..... 21.80.....35.20  
090773-91 .... PCB, populated and tested with Bootloader pre-programmed..... 56.00.....90.40

**Bluetooth for OBD-2**  
090918-71 .... PCB with SMDs fitted, BTM222 Bluetooth module..... 26.70.....43.10

**Fun with Fireflies**  
100014-1 ..... Printed circuit board..... 11.00.....17.80  
100014-41 .... Programmed controller..... 11.00.....17.80

**Beep, beep... Sesame**  
081143-41 .... Programmed controller..... 15.50.....25.00

**5V Power Controller**  
090719-1 ..... Printed circuit board..... 8.90.....14.40

March 2010 (No. 399)

**Reign with the Sceptre**  
090559-91 .... PCB, populated and tested, test software loaded (excluding Bluetooth module)..... 89.00.....143.60

**Modulo D**  
090563-71 .... PCB, SMD-populated, and all other components..... 69.90.....112.80

February 2010 (No. 398)

**Battery Checker**  
071131-41 .... ATmega32-16PU, programmed ..... 17.80.....28.80  
071131-71 .... Kit of parts, excl. enclosure ..... 124.00.....200.00

**Winamp Controller**  
090531-71 .... Kit of parts ..... 89.00.....143.60

**The ATM18 Radio Computer**  
090740-71 .... PCB with Si4734/35 radio IC ready mounted and tested..... 27.50.....44.40

January 2010 (No. 397)

**USB Magic Eye**  
090788-1 ..... Printed circuit board..... 9.90.....16.00  
090788-41 .... ATtiny2313-20PU, programmed ..... 9.90.....16.00

**MIAC for Home Automation**  
090278-91 .... Populated PCB in enclosure ..... 154.00.....248.40

**Dimmer with a Micro**  
090315-41 .... PIC12F629A, programmed..... 7.60.....12.30

# Bestsellers

Books	1		<b>PIC Cookbook</b> for Virtual Instrumentation ISBN 978-0-905705-84-2 .... £29.50 .....US \$47.60
	2		<b>Python Programming and GUIs</b> ISBN 978-0-905705-87-3 .... £29.50 .....US \$47.60
	3		<b>Complete practical measurement</b> using a PC ISBN 978-0-905705-79-8 .... £28.50 .....US \$46.00
	4		<b>C# 2008 and .NET programming</b> ISBN 978-0-905705-81-1 .... £29.50 .....US \$47.60
	5		<b>PIC Microcontrollers</b> ISBN 978-0-905705-70-5 .... £32.00 .....US \$51.70
CD/DVD-ROMS	1		<b>DVD High-End Valve Amplifiers</b> Masterclass ISBN 978-0-905705-86-6 .... £24.90 .... US \$40.20
	2		<b>DVD Elektor 2009</b> ISBN 978-90-5381-251-8 .... £17.50 .....US \$28.30
	3		<b>DVD Elektor 1990 through 1999</b> ISBN 978-0-905705-76-7 .... £69.00 ....US \$111.30
	4		<b>DVD LED Toolbox</b> ISBN 978-90-5381-245-7 .... £28.50 .....US \$46.00
	5		<b>CD ECD 5</b> ISBN 978-90-5381-159-7 .... £24.90 .....US \$40.20
Kits & Modules	1		<b>UniLab</b> Art. # 090786-71 ..... £64.00    US \$103.30
	2		<b>Modulo D</b> Art. # 090563-71 ..... £69.90 ...US \$112.80
	3		<b>Reign with the Sceptre</b> Art. # 090559-91 ..... £89.00 ...US \$143.60
	4		<b>Bluetooth for OBD-2</b> Art. # 090918-71 ..... £26.70 .....US \$43.10
	5		<b>SDR Preselector</b> Art. # 090615-71 ..... £47.00    US \$75.90

**Order quickly and securely through**  
[www.elektor.com/shop](http://www.elektor.com/shop)  
**or use the Order Form near the end of the magazine!**

**elektor**  
 Elektor  
 Regus Brentford  
 1000 Great West Road  
 Brentford TW8 9HH • United Kingdom  
 Tel. +44 20 8261 4509  
 Fax +44 20 8261 4447  
 Email: sales@elektor.com

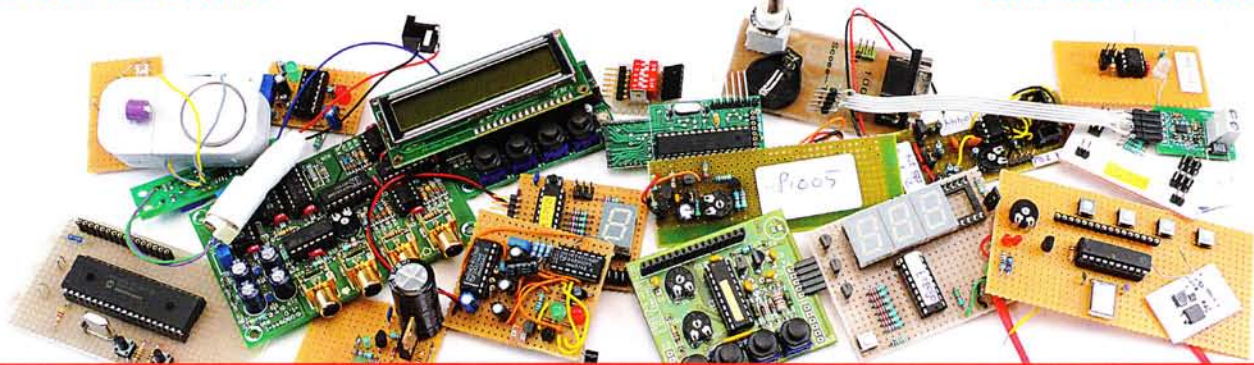

**Do not miss Elektor's best selling issue of the year — get your copy in time**

## Summer Circuits 2010 – Mega compilation of circuits, ideas and tips

'Summer Circuits', Elektor's extra-thick July & August double edition is the established Number-1 source of inspiration for all electronics enthusiasts. Elektor's editors and lab staff have again compiled a massive collection of small circuits, new IC apps, software and project development tips and ideas covering the whole gamut of electronics.

### From the contents

Slope meter	LED tester	Sweep generator	Bicycle rear light	Cheap channel zapper
FM test generator	Guitar compressor	Lithium battery charger	Magnet train	Capacitor tester
Voltage guard	3D pyramid with USB	Cable tester	Water alarm	Magnetotester

### Extra in the Summer Circuits 2010 edition: DSP General Coverage Receiver

A small general coverage receiver with lots of features was developed based on the SI4735 DSP chip. The radio has a two-line LCD and covers the long, medium and short wave bands, as well as VHF FM stereo with an RDS readout included. There's also automatic preselector tuning, switchable AM bandwidth and precision signal strength metering in dB $\mu$ V. The first part of this awesome project appears in the Summer Circuits 2010 edition.



Article titles and magazine contents subject to change; please check the Magazine tab on [www.elektor.com](http://www.elektor.com)  
Elektor UK/European edition: on sale June 24, 2010. Elektor USA edition: published June 17, 2010.

[www.elektor.com](http://www.elektor.com) [www.elektor.com](http://www.elektor.com) [www.elektor.com](http://www.elektor.com) [www.elektor.com](http://www.elektor.com) [www.elektor.com](http://www.elektor.com) [www.elektor.com](http://www.elektor.com)

## Elektor on the web

All magazine articles back to volume 2000 are available online in pdf format. The article summary and parts list (if applicable) can be instantly viewed to help you positively identify an article. Article related items are also shown, including software downloads, circuit boards, programmed ICs and corrections and updates if applicable. Complete magazine issues may also be downloaded.

In the Elektor Shop you'll find all other products sold by the publishers, like CD-ROMs, DVDs, kits, modules, equipment, tools and books. A powerful search function allows you to search for items and references across the entire website.

### Also on the Elektor website:

- Electronics news and Elektor announcements
- Readers Forum
- PCB, software and e-magazine downloads
- Time limited offers
- FAQ, Author Guidelines and Contact

Description	Price each	Qty.	Total	Order Code
50 PIC Microcontroller projects	<b>NEW</b> £36.00			
Python Programming and GUIs	<b>NEW</b> £29.50			
DVD Masterclass				
High-End Valve Amplifiers	<b>NEW</b> £24.90			
DVD Elektor 2009	£17.50			
PIC Cookbook for Virtual Instrumentation	£29.50			
			<i>Sub-total</i>	
			<i>P&amp;P</i>	
			<b>Total paid</b>	

Prices and item descriptions subject to change. The publishers reserve the right to change prices without prior notification. Prices and item descriptions shown here supersede those in previous issues. E. & O.E.

Name \_\_\_\_\_

Address + Post code \_\_\_\_\_  
\_\_\_\_\_

Tel. \_\_\_\_\_

Email \_\_\_\_\_

Date - - -

Signature \_\_\_\_\_

EL06

METHOD OF PAYMENT  
(see reverse before ticking as appropriate)

- Bank transfer  
 Cheque  
 (UK-resident customers ONLY)  
 Giro transfer



\_\_\_\_\_  
 \_\_\_\_\_

Expiry date: \_\_\_\_\_

Verification code: \_\_\_\_\_

Please send this order form to\*  
(see reverse for conditions)

**Elektor**  
**Regus Brentford**  
**1000 Great West Road**  
**Brentford TW8 9HH**  
**United Kingdom**

Tel.: +44 20 8261 4509  
 Fax: +44 20 8261 4447  
 www.elektor.com  
 sales@elektor.com

\*USA and Canada residents should use \$ prices,  
 and send the order form to:  
 Elektor US  
 PO Box 180  
 Vernon CT 06066  
 USA  
 Phone: 860-875-2199  
 Fax: 860-871-0411  
 E-mail: sales@elektor.com

**Yes, I am taking out an annual subscription  
 to Elektor and receive the E-book  
 Microcontroller Basics totally free!\***

(Please fill in your emailaddress below)

I would like:

- Standard Subscription (11 issues)  
 Subscription-Plus  
 (11 issues plus the Elektor Volume 2010 DVD-ROM  
 + exclusive access to www.elektor-plus.com)

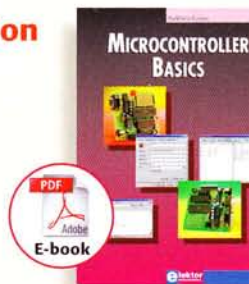

**TIP**

\* Offer available to Subscribers who have not held a subscription to Elektor during the last 12 months. Offer subject to availability. See reverse for rates and conditions.

Name \_\_\_\_\_

Address + Post code \_\_\_\_\_  
\_\_\_\_\_

Tel. \_\_\_\_\_

Email \_\_\_\_\_

Date - - -

Signature \_\_\_\_\_

EL06

METHOD OF PAYMENT  
(see reverse before ticking as appropriate)

- Bank transfer  
 Cheque  
 (UK-resident customers ONLY)  
 Giro transfer



\_\_\_\_\_  
 \_\_\_\_\_

Expiry date: \_\_\_\_\_

Verification code: \_\_\_\_\_

Please send this order form to

**Elektor**  
**Regus Brentford**  
**1000 Great West Road**  
**Brentford TW8 9HH**  
**United Kingdom**

Tel.: +44 20 8261 4509  
 Fax: +44 20 8261 4447  
 www.elektor.com  
 subscriptions@elektor.com

## ORDERING INSTRUCTIONS, P&P CHARGES

All orders, except for subscriptions (for which see below), must be sent BY POST or FAX to our Brentford address using the Order Form overleaf. Online ordering: [www.elektor.com/shop](http://www.elektor.com/shop)

**Readers in the USA and Canada** should send orders, except for subscriptions (for which see below), to the USA address given on the order form. Please apply to Elektor US for applicable P&P charges. Please allow 4-6 weeks for delivery.

**Orders placed on our Brentford office** must include P&P charges (Priority or Standard) as follows: Europe: £6.00 (Standard) or £7.00 (Priority) Outside Europe: £9.00 (Standard) or £11.00 (Priority)

## HOW TO PAY

All orders must be accompanied by the full payment, including postage and packing charges as stated above or advised by Customer Services staff.

**Bank transfer** into account no. 40270211 held by Elektor International Media BV with The Royal Bank of Scotland, London. IBAN: GB96 ABNA 4050 3040 2702 11. BIC: ABNAGB2L. Currency: sterling (UKP).

Please ensure your full name and address gets communicated to us.

**Cheque** sent by post, made payable to Elektor Electronics. We can only accept sterling cheques and bank drafts from UK-resident customers or subscribers. We regret that no cheques can be accepted from customers or subscribers in any other country.

**Giro transfer** into account no. 34-152-3801, held by Elektor International Media BV. Please do not send giro transfer/deposit forms directly to us, but instead use the National Giro postage paid envelope and send it to your National Giro Centre.

**Credit card** VISA and MasterCard can be processed by mail, email, web, fax and telephone. Online ordering through our website is SSL-protected for your security.

## COMPONENTS

Components for projects appearing in Elektor are usually available from certain advertisers in this magazine. If difficulties in the supply of components are envisaged, a source will normally be advised in the article. Note, however, that the source(s) given is (are) not exclusive.

## TERMS OF BUSINESS

**Delivery** Although every effort will be made to dispatch your order within 2-3 weeks from receipt of your instructions, we can not guarantee this time scale for all orders. **Returns** Faulty goods or goods sent in error may be returned for replacement or refund, but not before obtaining our consent. All goods returned should be packed securely in a padded bag or box, enclosing a covering letter stating the dispatch note number. If the goods are returned because of a mistake on our part, we will refund the return postage. **Damaged goods**

Claims for damaged goods must be received at our Brentford office within 10-days (UK); 14-days (Europe) or 21-days (all other countries).

**Cancelled orders** All cancelled orders will be subject to a 10% handling charge with a minimum charge of £5.00. **Patents** Patent protection may exist in respect of circuits, devices, components, and so on, described in our books and magazines. Elektor does not accept responsibility or liability for failing to identify such patent or other protection. **Copyright** All drawings, photographs, articles, printed circuit boards, programmed integrated circuits, diskettes and software carriers published in our books and magazines (other than in third-party advertisements) are copyright and may not be reproduced or transmitted in any form or by any means, including photocopying and recording, in whole or in part, without the prior permission of Elektor in writing. Such written permission must also be obtained before any part of these publications is stored in a retrieval system of any nature. Notwithstanding the above, printed-circuit boards may be produced for private and personal use without prior permission. **Limitation of liability** Elektor shall not be liable in contract, tort, or otherwise, for any loss or damage suffered by the purchaser whatsoever or howsoever arising out of, or in connexion with, the supply of goods or services by Elektor other than to supply goods as described or, at the option of Elektor, to refund the purchaser any money paid in respect of the goods. **Law** Any question relating to the supply of goods and services by Elektor shall be determined in all respects by the laws of England.

January 2010

## SUBSCRIPTION RATES FOR ANNUAL

### SUBSCRIPTION

	Standard	Plus
United Kingdom & Ireland	£49.00	£61.50
Surface Mail		
Rest of the World	£63.00	£75.50
Airmail		
Rest of the World	£79.00	£91.50
USA	£64.95	See <a href="http://www.elektor.com/usa">www.elektor.com/usa</a> for special offers
Canada	£75.95	

## HOW TO PAY

**Bank transfer** into account no. 40270211 held by Elektor International Media BV with The Royal Bank of Scotland, London. IBAN: GB96 ABNA 4050 3040 2702 11. BIC: ABNAGB2L. Currency: sterling (UKP). Please ensure your full name and address gets communicated to us.

**Cheque** sent by post, made payable to Elektor Electronics. We can only accept sterling cheques and bank drafts from UK-resident customers or subscribers. We regret that no cheques can be accepted from customers or subscribers in any other country.

**Giro transfer** into account no. 34-152-3801, held by Elektor International Media BV. Please do not send giro transfer/deposit forms directly to us, but instead use the National Giro postage paid envelope and send it to your National Giro Centre.

**Credit card** VISA and MasterCard can be processed by mail, email, web, fax and telephone. Online ordering through our website is SSL-protected for your security.

## SUBSCRIPTION CONDITIONS

The standard subscription order period is twelve months. If a permanent change of address during the subscription period means that copies have to be despatched by a more expensive service, no extra charge will be made. Conversely, no refund will be made, nor expiry date extended, if a change of address allows the use of a cheaper service.

Student applications, which qualify for a 20% (twenty per cent) reduction in current rates, must be supported by evidence of studentship signed by the head of the college, school or university faculty.

A standard Student Subscription costs £39.20, a Student Subscription-Plus costs £51.70 (UK only).

Please note that new subscriptions take about four weeks from receipt of order to become effective. Cancelled subscriptions will be subject to a charge of 25% (twenty-five per cent) of the full subscription price or £7.50, whichever is the higher, plus the cost of any issues already dispatched. Subscriptions cannot be cancelled after they have run for six months or more.

January 2010



# Prototypes Multilayer Professional PCBs



## Order custom-designed boards from the Elektor PCB Service

### The advantages at a glance

- Professional quality PCBs.
- No film charges or start-up charges.
- No minimum order quantity or charge for this service.
- Available to private and commercial customers.
- Design check applied to all entries. We'll let you know within 4 hours!
- Two PCBs supplied – three produced.  
If the third board is also okay, you receive it as well – free of charge!

## Quick, cheap and secure

## www.elektorpcbservice.com

### INDEX OF ADVERTISERS

Astrobe, Showcase .....	www.astrobe.com .....	78	Labcenter.....	www.labcenter.com .....	88
APD, Showcase .....	www.apdanglia.org.uk .....	79	MikroElektronika .....	www.mikroe.com .....	2
Atomic Programming Ltd, Showcase .....	www.atomicprogramming.com .....	78	MQP Electronics, Showcase .....	www.mqp.com .....	79
Avit Research, Showcase .....	www.avitresearch.co.uk .....	78	Nurve Networks .....	www.xgamestation.com .....	23
Beta Layout, Showcase .....	www.pcb-pool.com .....	9, 78	Parallax .....	www.parallax.com .....	23
Black Robotics, Showcase .....	www.blackrobotics.com .....	78	Peak Electronic Design.....	www.peakelec.co.uk .....	9
ByVac, Showcase .....	www.byvac.com .....	78	Pico .....	www.picotech.com/scope2008 .....	9
CEDA, Showcase .....	www.ceda.in .....	78	Quasar Electronics .....	www.quasarelectronics.com .....	15
Decibit Co, Ltd, Showcase .....	www.decibit.com .....	78	Robot Electronics, Showcase .....	www.robot-electronics.co.uk .....	79
Designer Systems, Showcase .....	www.designersystems.co.uk .....	78	Robotiq, Showcase .....	www.robotiq.co.uk .....	79
Easysync, Showcase .....	www.easysync.co.uk .....	78	RS Components .....	www.rswww.com/edp .....	3
Electronica 2010 .....	www.electronica.de/en .....	57	Schaeffer AG .....	www.schaeffer-ag.de .....	23
Elneq, Showcase .....	www.elneq.com .....	78	Showcase .....	78, 79	
Eurocircuits .....	www.eurocircuits.com .....	74	USB Instruments, Showcase .....	www.usb-instruments.com .....	79
First Technology Transfer Ltd, Showcase .....	www.ftt.co.uk .....	78	Virtins Technology, Showcase .....	www.virtins.com .....	79
FlexiPanel Ltd, Showcase .....	www.flexipanel.com .....	78			
Future Technology Devices, Showcase .....	www.ftdichip.com .....	2, 79			
Hameg, Showcase .....	www.hameg.com .....	78			
HexWax Ltd, Showcase .....	www.hexwax.com .....	79			

**Advertising space for the issue 19 August 2010  
may be reserved not later than 20 July 2010**

with Huson International Media - Cambridge House - Gogmore Lane - Chertsey, Surrey KT16 9AP - England - Telephone 01932 564 999 - Fax 01932 564 998 - e-mail: ros.elgar@husonmedia.com to whom all correspondence, copy instructions and artwork should be addressed.

## PRE-PRODUCTION CHECK

Board Edge Defined - **CHECK**

All Components Placed - **CHECK**

All Connections Routed - **CHECK**

Power Planes Generated - **CHECK**

No Design Rule Violations - **CHECK**

# PROTEUS 7

## Design with Confidence:

The latest version of the Proteus PCB Design Software provides a multi-stage Pre-Production Check which will detect and prevent a variety of common mistakes prior to your boards being sent for manufacture.

## PROTEUS DESIGN SUITE Features:

- Hardware Accelerated Performance.
- Unique Thru-View™ Board Transparency.
- Over 35k Schematic & PCB library parts.
- Integrated Shape Based Auto-router.
- Flexible Design Rule Management.
- Polygonal and Split Power Plane Support.
- Board Autoplacement & Gateswap Optimiser.
- Direct CAD/CAM, ODB++, IDF & PDF Output.
- Integrated 3D Viewer with 3DS and DXF export.
- Mixed Mode SPICE Simulation Engine.
- Co-Simulation of PIC, AVR, 8051 and ARM7.
- Direct Technical Support at no additional cost.

All levels of the **Proteus Design Suite** include a world class, fully integrated shape-based autorouter at no additional cost - prices start from just £150 exc. VAT & delivery

**labcenter**  [www.labcenter.com](http://www.labcenter.com)  
**Electronics**

Labcenter Electronics Ltd. 53-55 Main Street, Grassington, North Yorks. BD23 5AA.  
Registered in England 4692454 Tel: +44 (0)1756 753440, Email: [info@labcenter.com](mailto:info@labcenter.com)

Visit our website or  
phone 01756 753440  
for more details



50+ pages  
build & learn

June 2010

AUS\$ 13.90 - NZ\$ 16.90 - SAR 99.95 £ 4.65

**+ WHAT Free Audio Measuring Software**

# Elektor

www.elektor.com

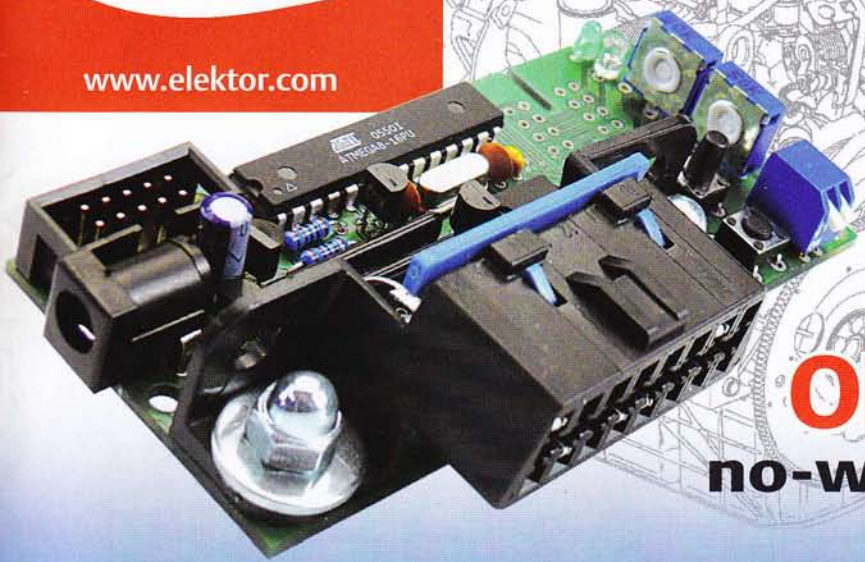

**+ DMX512 Interface**

**+ LiPo Balancer**

**+ Starry Night**

**OBD2 Simulator**  
no-wheels car electronics

**Programmable  
DIY RFID**

- ✓ home-brew tags
- ✓ wireless electricity

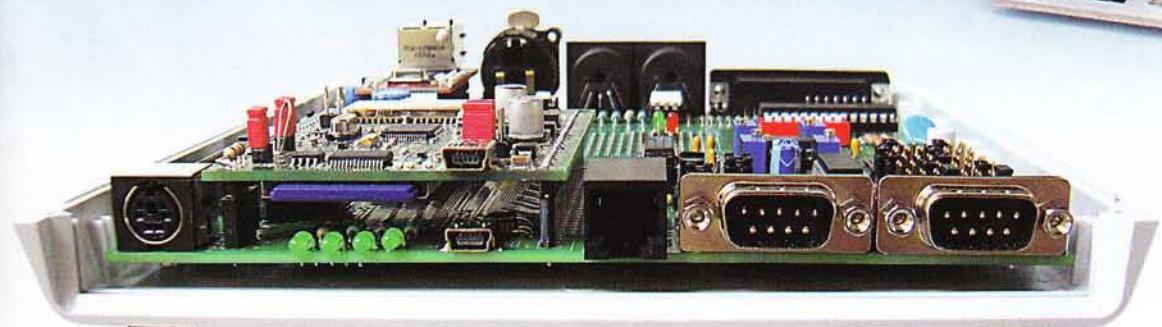
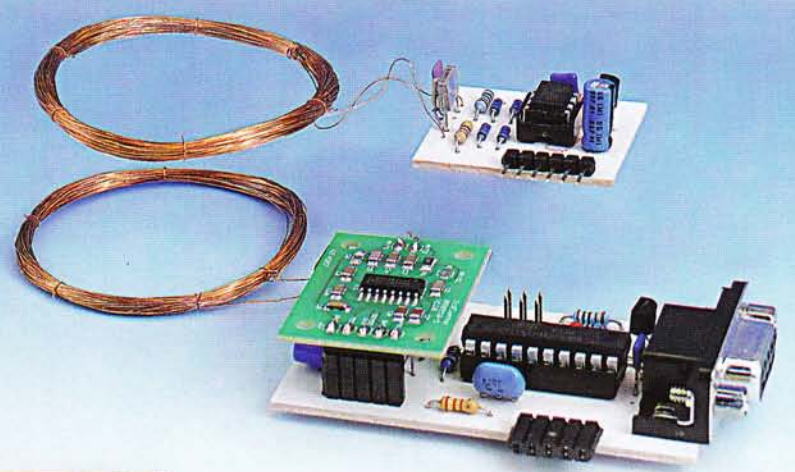

**InterSceptre Extension Board**

opens doors (and ports) for you

